

Form 8484  
June, 1918

# LIST OF PARTS



From the library of: Diamond Needle Corp

## MACHINES

Nos. 52-55 and 52-75

---

\*\* A TRADE MARK OF  
THE SINGER MANUFACTURING COMPANY

# INSTRUCTIONS FOR OILING

---

To ensure easy running and prevent unnecessary wear of the parts which are in movable contact, the machine requires oiling, and when in continuous use, "TYPE B" or "TYPE D" OIL, sold only by Singer Sewing Machine Company, should be applied at least twice each day to all oil holes marked "OIL", as instructed in Form 19768. "TYPE D" OIL is stainless.

## INDEX

---

|                              | PAGE |
|------------------------------|------|
| ACCESSORIES.....             | 15   |
| CORDER.....                  | 15   |
| FEED ROLLS.....              | 20   |
| FOOT LIFTER PARTS.....       | 17   |
| IRON BASE.....               | 15   |
| KNEE LIFTER PARTS.....       | 18   |
| MACHINE NO. 52-55.....       | 7    |
| "    "    52-75.....         | 14   |
| NUMERICAL LIST OF PARTS..... | 25   |
| OBSOLETE PARTS.....          | 23   |
| PRESSER FOOT.....            | 16   |
| TAPE HOLDERS.....            | 16   |
| THREAD UNWINDER PARTS.....   | 19   |
| UNDER DRIVER.....            | 21   |

From the library of: Diamond Needle Corp

COPYRIGHT  
U. S. A.,  
1914 AND 1918  
BY  
THE SINGER MANUFACTURING CO.  
ALL RIGHTS RESERVED FOR ALL COUNTRIES

# INSTRUCTIONS FOR ORDERING

In ordering from this list, use ONLY the part NUMBER in the FIRST column.

The number stamped on a Sewing Machine part is in every case the number of the single part only.

Every combination of parts sent out as such has its specific number, which, although not stamped on the parts, must be used when ordering the combination.

Each number always indicates the SAME PART in whatever list it appears, or for whatever machine.

The letters after some of the numbers indicate the style of finish only, as follows:

- A. Hardened, Polished and Plated.
- B. Polished and Plated
- C. Hardened only.
- D. Polished only.
- E. Soft, not Polished.
- F. Hardened and Polished.
- G.
- H. Blued.
- J. Plated only.
- K. Hardened and Plated.
- L. Brass or Gilt.
- M. Oxidized.
- P. Japanned.

These letters MUST BE USED when they appear in the list, and AFTER the number as in the list.

In this series

- 1 to 1500 and 50001 to 51500 are Screw Numbers.
- 1501 to 1800 are Nut Numbers.
- 1801 to 2000 are Roller Numbers.
- 2001 to 50000 and 52001 and upward are numbers of Machine Parts.

The figures in the second column refer only to the plates, illustrating the parts, and are NOT TO BE USED in ordering.

Parts marked with an asterisk (\*) are furnished only when repairs are made at factory.

# LIST OF PARTS COMPLETE

FOR

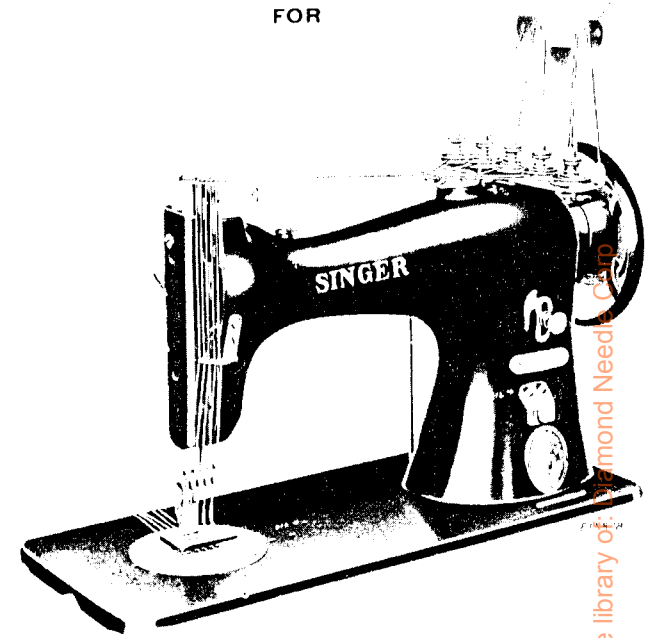

From the library of: Raymond Needles Co.

## MACHINE No. 52-55

FIVE NEEDLES. FIVE HOOKS

| NO.    | PLATE | NAME                                                   |
|--------|-------|--------------------------------------------------------|
| *13789 | —     | Arm.....                                               |
| 4389   | 7445  | " Dowel Pin.....                                       |
| 54897  | 7442  | " Oil Cup.....                                         |
| 13862  | 7442  | " " Tube with 29599, for oiling 13799 and 13804.....   |
| 13831  | 7442  | Arm Oil Tube (left) with 49092, for oiling 13811.....  |
| 13832  | 7442  | Arm Oil Tube (right) with 49092, for oiling 13813..... |
| 13833  | —     | Arm Oil Tube Bracket.....                              |
| 13834  | 7442  | " " " " 13833 with 13831 and 13832.....                |

| NO.    | PLATE | NAME                                                             |
|--------|-------|------------------------------------------------------------------|
| 898D   | 7450  | Arm Oil Tube Bracket Screw.....                                  |
| 29599  | 7442  | “ “ “ Packing (felt) for 13862,<br>..... per 100                 |
| 49092  | 7442  | Arm Oil Tube Packing (felt) for 13831<br>and 13832.....          |
| 880E   | 7450  | Arm Screw (left).....                                            |
| 138E   | 7450  | “ “ (right).....                                                 |
| 13793  | 7440  | “ Shaft.....                                                     |
| 13794  | 7440  | “ “ Flanged Bushing (back)....                                   |
| 56006  | 7442  | “ “ “ “ “ Oil<br>Pad (braided cotton).....                       |
| 446C   | 2831  | Arm Shaft Flanged Bushing (back) Set<br>Screw.....               |
| 13795  | 7440  | Arm Shaft Flanged Bushing (front)...                             |
| 56006  | 7442  | “ “ “ “ “ Oil<br>Pad (braided cotton).....                       |
| 443C   | 7450  | Arm Shaft Flanged Bushing (front) Set<br>Screw.....              |
| 144D   | 7450  | Arm Shaft Screw.....                                             |
| 15196  | 7441  | “ Side Cover.....                                                |
| 286D   | 7450  | “ “ “ Thumb Screw.....                                           |
| 13796  | 7441  | Balance Wheel, 2 $\frac{3}{8}$ in. pulley, with two<br>448c..... |
| 13797  | 7441  | Balance Wheel Oil Cover.....                                     |
| 210D   | 7450  | “ “ “ “ Screw.....                                               |
| 448C   | 7450  | “ “ Set Screw.....                                               |
| *13798 | —     | Bed.....                                                         |
| 13799  | 7441  | Crank Connecting Rod with 13800 and<br>two 145E.....             |
| *13800 | —     | Crank Connecting Rod Cap.....                                    |
| 145E   | 7450  | “ “ “ “ Screw.....                                               |
| 375C   | 7450  | “ “ “ Hinge Screw.....                                           |
| 1518E  | 7450  | “ “ “ “ “ Nut.....                                               |
| 13849  | 7441  | Face Plate.....                                                  |
| 190D   | 7442  | “ “ Screw.....                                                   |
| 13802  | 7443  | Feed Bar.....                                                    |
| 315C   | 2642  | “ “ Screw Centre.....                                            |
| 1519E  | 7450  | “ “ “ “ Nut.....                                                 |
| 2039   | 7444  | “ Connecting Link.....                                           |
| 378C   | 7444  | “ “ “ Hinge Screw (long)                                         |
| 380C   | 7444  | “ “ “ “ “ (short)                                                |
| 1520E  | 7444  | “ “ “ “ “ Nut.....                                               |
| 48003  | 5401  | “ Dog.....                                                       |
| 48004  | 5402  | “ “.....                                                         |
| 48005  | 5403  | “ “.....                                                         |
| 48006  | 5404  | “ “.....                                                         |
| 48009  | 5407  | “ “.....                                                         |
| 48002  | 5400  | “ “ for gathering.....                                           |

| NO.    | PLATE | NAME                                                                   |
|--------|-------|------------------------------------------------------------------------|
| 48007  | 5405  | Feed Dog, for gathering.....                                           |
| 48008  | 5406  | “ “ “ “ and underbraiding                                              |
| 191C   | 7450  | “ “ Screw.....                                                         |
| 13803  | 7444  | “ and Feed Lifting Eccentric with<br>448c.....                         |
| 448C   | 7450  | Feed and Feed Lifting Eccentric Set<br>Screw.....                      |
| 13804  | 7444  | Feed and Feed Lifting Eccentric Sleeve..                               |
| 13805  | 7440  | “ Forked Connection.....                                               |
| 378C   | 7444  | “ “ “ Hinge Screw....                                                  |
| 1520E  | 7444  | “ “ “ “ “ Nut                                                          |
| 13806  | 7440  | “ Lifting Rock Shaft.....                                              |
| 13807  | —     | Feed Lifting Rock Shaft complete, Nos.<br>2509 and 13806.....          |
| 13808  | 7440  | Feed Lifting Rock Shaft Connecting Rod<br>with 43977 and two 145E..... |
| *43977 | —     | Feed Lifting Rock Shaft Connecting Rod<br>Cap.....                     |
| 145E   | 7450  | Feed Lifting Rock Shaft Connecting Rod<br>Cap Screw.....               |
| 375C   | 7450  | Feed Lifting Rock Shaft Connecting Rod<br>Hinge Screw.....             |
| 1518E  | 7450  | Feed Lifting Rock Shaft Connecting Rod<br>Hinge Screw Nut.....         |
| 2509   | 7444  | Feed Lifting Rock Shaft Crank with 157J<br>and 1813.....               |
| 157J   | 7444  | Feed Lifting Rock Shaft Crank Clamping<br>Screw.....                   |
| 1813   | 7444  | Feed Lifting Rock Shaft Crank Roller and<br>Stud.....                  |
| 307C   | 7450  | Feed Lifting Rock Shaft Screw Centre                                   |
| 1513J  | 2642  | “ “ “ “ “ “<br>Nut.....                                                |
| 2164   | 7444  | Feed Regulator.....                                                    |
| 74E    | 7444  | “ “ Hinge Screw.....                                                   |
| 747D   | 7444  | “ “ Thumb Screw.....                                                   |
| 21350  | 7444  | “ “ “ “ Stop.....                                                      |
| 2047   | 7440  | “ Rock Shaft.....                                                      |
| 2046   | —     | Feed Rock Shaft complete, Nos. 2047 and<br>2048.....                   |
| 2048   | 7444  | Feed Rock Shaft Crank with 465c.....                                   |
| 2049   | 7444  | “ “ “ “ Pin.....                                                       |
| 465C   | 7444  | “ “ “ “ Set Screw.....                                                 |
| 307C   | 7450  | “ “ “ Screw Centre.....                                                |
| 1513J  | 2642  | “ “ “ “ “ Nut.....                                                     |
| 13809  | 7445  | Looper.....                                                            |
| 13810  | 7461  | “ Carrier with two 237F and five<br>853c.....                          |

| NO.    | PLATE | NAME                                                                                       |
|--------|-------|--------------------------------------------------------------------------------------------|
| 237F   | 7450  | Looper Carrier Set Screw.....                                                              |
| 13516  | 7445  | " " Shaft.....                                                                             |
| 13836  | 7445  | " " " Bushing.....                                                                         |
| 448c   | 7450  | " " " " Set Screw..                                                                        |
| 217F   | 7450  | " " " Set Screw.....                                                                       |
| 13811  | 7441  | " Driving Shaft with 217F.....                                                             |
| 13812  | 7445  | " " " Crank with two<br>1253c.....                                                         |
| 1253c  | 7445  | Looper Driving Shaft Crank Set Screw...                                                    |
| 13813  | 7445  | " " " Link.....                                                                            |
| 13814  | 7445  | " " " " Hinge Pin...                                                                       |
| 1253c  | 7445  | " " " " " " Set<br>Screw.....                                                              |
| 853c   | 7450  | Looper Set Screw.....                                                                      |
| 13581  | 7441  | Needle Bar (hollow).....                                                                   |
| 13582  | 7444  | " " Connecting Link with 794E..                                                            |
| 794E   | 7444  | " " " " Adjusting<br>Screw.....                                                            |
| 881c   | 7444  | Needle Bar Connecting Link Hinge Screw                                                     |
| 13896  | 7444  | " " " Stud with 1904<br>and two 175e.....                                                  |
| 175E   | 7444  | Needle Bar Connecting Stud Clamping<br>Screw.....                                          |
| 1904   | 7444  | Needle Bar Connecting Stud Roller<br>(roller only).....                                    |
| 13816  | 7440  | Needle Bar Crank with 435c and 1293c.                                                      |
| 1293c  | 7450  | " " " Position Screw.....                                                                  |
| 435c   | 2831  | " " " Set Screw.....                                                                       |
| 13560  | 7461  | " Clamp with five 620F or 50014F,<br>for $\frac{1}{8}$ in. to $\frac{3}{4}$ in. gauge..... |
| 13817  | 7461  | Needle Clamp with five 50014F, for $\frac{3}{16}$ in.<br>gauge and above.....              |
| 2273   | 7445  | Needle Clamp Pin.....                                                                      |
| 620F   | 7445  | " Set Screw for 13560.....                                                                 |
| 50014F | 7445  | " " " $\frac{3}{16}$ in. gauge and<br>above.....                                           |
| 13818  | 7445  | Oscillating Rock Shaft with 1253c.....                                                     |
| 13819  | 7445  | " " " Hinge Pin.....                                                                       |
| 13820  | 7445  | " " " " Bushing                                                                            |
| 448c   | 7450  | " " " " " S e t<br>Screw.....                                                              |
| 2058   | 7441  | Presser Bar.....                                                                           |
| 52016  | 7445  | " " Lifter.....                                                                            |
| 1058c  | 7445  | " " " Hinge Screw.....                                                                     |
| 1520E  | 7444  | " " " " Nut.....                                                                           |
| 2953   | 7445  | " " Lifting Bracket with 453c...                                                           |
| 453c   | 2831  | " " " " Set Screw...                                                                       |
| 3100   | 7445  | " " Spring.....                                                                            |

| NO.   | PLATE | NAME                                                                                                                                                                                                                                          |
|-------|-------|-----------------------------------------------------------------------------------------------------------------------------------------------------------------------------------------------------------------------------------------------|
| 2070  | 7445  | Presser Bar Spring Washer.....                                                                                                                                                                                                                |
| 30344 | 4685  | " Foot, for braiding.....                                                                                                                                                                                                                     |
| 30353 | 4687  | " " " cording, with guide for<br>upper strip and two cord tubes.....                                                                                                                                                                          |
| 31136 | 3037  | Presser Foot, for gathering.....                                                                                                                                                                                                              |
| 31142 | 3094  | " " " " leaving out the<br>first needle from the right hand side...                                                                                                                                                                           |
| 30345 | 5499  | Presser Foot, for general work.....                                                                                                                                                                                                           |
| 31135 | 3037  | " " " " leaving out<br>the first needle from the right hand side                                                                                                                                                                              |
| 30343 | 5498  | Presser Foot, for strip cording, with guides<br>for upper and under strips.....                                                                                                                                                               |
| 31134 | 3036  | Presser Foot, for strip cording, with guides<br>for upper and under strips, leaving out<br>the first needle from the right hand side                                                                                                          |
| 30355 | 3034  | Presser Foot, for strip cording, with guides<br>for upper and under strips and two cord<br>tubes.....                                                                                                                                         |
| 31154 | 5431  | Presser Foot, for strip cording, with guides<br>for upper and under strips and four cord<br>tubes.....                                                                                                                                        |
| 31131 | 3035  | Presser Foot, for strip folding, with four<br>cord tubes.....                                                                                                                                                                                 |
| 31156 | 5446  | Presser Foot, for rims of soft hats.....                                                                                                                                                                                                      |
| 30352 | 5497  | " " " top and bottom cording                                                                                                                                                                                                                  |
| 31161 | 5499  | " " (double hinged) for braiding                                                                                                                                                                                                              |
| 31160 | 5460  | " " (hinged) for braiding.....                                                                                                                                                                                                                |
| 31158 | 5446  | " " " " general work..                                                                                                                                                                                                                        |
| 31159 | 5459  | " " " " strip cording<br>with guides for upper and under strips<br>and four tubes.....                                                                                                                                                        |
| 31151 | 4663  | Presser Foot (hinged, adjustable) for<br>gathering, for 48002.....                                                                                                                                                                            |
| 31157 | 5447  | Presser Foot (hinged, adjustable) for<br>gathering, leaving out the second needle<br>from the right hand side.....                                                                                                                            |
| 30351 | 4687  | Presser Foot (hinged, tube) for reeding<br>between the first and second needles<br>from the right hand side and the first<br>and second needles from the left hand<br>side with centre space for steel, leaving<br>out the centre needle..... |
| 30349 | 4686  | Presser Foot (hinged, tube) for reeding<br>between the second and centre needles<br>from the right hand side and the second<br>and centre needles from the left hand<br>side.....                                                             |

| NO.   | PLATE | NAME                                                                                                                                                                                                                              |
|-------|-------|-----------------------------------------------------------------------------------------------------------------------------------------------------------------------------------------------------------------------------------|
| 30348 | 4685  | Presser Foot (hinged, tube) for reeding between the second needle from the right hand side and the centre needle, leaving out the first needle from the right hand side and the first and second needles from the left hand side. |
| 30350 | 4686  | Presser Foot (hinged, tube) for reeding, leaving out the first needle from the right hand side.                                                                                                                                   |
| 31137 | 3038  | Presser Foot (side hinged) for general work.                                                                                                                                                                                      |
| 31138 | 3038  | Presser Foot (strip folding).                                                                                                                                                                                                     |
| 31141 | 3093  | " " " " for covering two cords with two strips, leaving out the centre needle.                                                                                                                                                    |
| 31147 | 3094  | Presser Foot (strip folding) leaving out the centre needle, the first needle from the right hand side and the second needle from the left hand side.                                                                              |
| 31140 | 3093  | Presser Foot (strip folding) with two cord tubes, for cording between the first and second needles from the right hand side and the first and second needles from the left hand side.                                             |
| 31132 | 3035  | Presser Foot (strip folding) with three cord tubes, leaving out the first needle from the right hand side.                                                                                                                        |
| 31133 | 3036  | Presser Foot (strip folding) with five cord tubes, leaving out the first needle from the right hand side.                                                                                                                         |
| 30354 | 3034  | Presser Foot (strip folding) with six cord tubes.                                                                                                                                                                                 |
| 31145 | 3096  | Presser Foot (strip folding) with interlining guide.                                                                                                                                                                              |
| 31144 | 3095  | Presser Foot (strip folding) with interlining guide, leaving out the first needle from the right hand side.                                                                                                                       |
| 31149 | 4635  | Presser Foot, slotted for tape, to stitch left hand edge of tape.                                                                                                                                                                 |
| 30346 | 5498  | Presser Foot (tube).                                                                                                                                                                                                              |
| 30342 | 4684  | " " " " for reeding.                                                                                                                                                                                                              |
| 30341 | 4684  | " " " " two strips, for reeding.                                                                                                                                                                                                  |
| 31150 | 7541  | Presser Foot (tube) for two strips, leaving out the first needle from the right hand side.                                                                                                                                        |
| 31155 | 7541  | Presser Foot (tube) leaving out the first needle from the right hand side.                                                                                                                                                        |

| NO.    | PLATE | NAME                                                                                                    |
|--------|-------|---------------------------------------------------------------------------------------------------------|
| 31148  | 4634  | Presser Foot with upper and lower strip folder.                                                         |
| 31153  | 4665  | Presser Foot with upper and lower strip folder, leaving out the first needle from the right hand side.  |
| 190D   | 7442  | Presser Foot Screw.                                                                                     |
| 263E   | 7450  | Pressure Regulating Thumb Screw.                                                                        |
| 13837  | 7460  | Tension Bracket with nine 13589.                                                                        |
| 13838  | —     | Tension Bracket complete, Nos. 828c, 13837, four each 637c, 1547D, five each 1560c, 13710 and ten 2921. |
| 2921   | 7442  | Tension Disc.                                                                                           |
| 13589  | 7442  | " " Steady Pin.                                                                                         |
| 1560c  | 7442  | " Regulating Thumb Nut.                                                                                 |
| 637c   | 7442  | " Screw Stud.                                                                                           |
| 828c   | 7442  | " " " for centre tension.                                                                               |
| 1547D  | 7442  | " " " Nut.                                                                                              |
| 13710  | 7442  | " Spring.                                                                                               |
| 13589  | 7442  | " Thread Guide Pin.                                                                                     |
| 13839  | —     | Thread Guide (back of arm) six holes.                                                                   |
| 13840  | 7462  | " " " " 13839 with 13862.                                                                               |
| 13841  | 7461  | Thread Guide (side of arm) five holes.                                                                  |
| 219D   | 7450  | " " " " " Screw.                                                                                        |
| 13842  | —     | " " (top of arm) six holes.                                                                             |
| 13843  | 7463  | " " " " " 13842 with 13862.                                                                             |
| 50062J | 7450  | Thread Guide (top of arm) Screw.                                                                        |
| 13844  | 7442  | " Controller Post.                                                                                      |
| 190D   | 7442  | " " " Screw.                                                                                            |
| 13845  | 7442  | " " Spring.                                                                                             |
| 233D   | 7442  | " " " Screw.                                                                                            |
| 13846  | 7442  | " " Thread Guide.                                                                                       |
| 13847  | —     | Thread Controller complete, Nos. 233D, 13844 and 13845.                                                 |
| 13594  | 7445  | Thread Take-up Plate.                                                                                   |
| 883B   | 7445  | " " " Screw.                                                                                            |
| 48022  | 5400  | Throat Plate for 48002.                                                                                 |
| 48023  | 5401  | " " " 48003.                                                                                            |
| 48024  | 5402  | " " " 48004.                                                                                            |
| 48026  | 5404  | " " " 48006.                                                                                            |
| 48027  | 5405  | " " " 48007.                                                                                            |
| 48029  | 5407  | " " " 48009.                                                                                            |
| 48028  | 5406  | " " " 48008, for gathering and underbraiding.                                                           |
| 48025  | 5403  | Throat Plate for 48005, for under strip.                                                                |
| 691F   | 7450  | " " " Screw.                                                                                            |
| 13635  | 1514  | Drip Pan with four 1 in. wire nails.                                                                    |

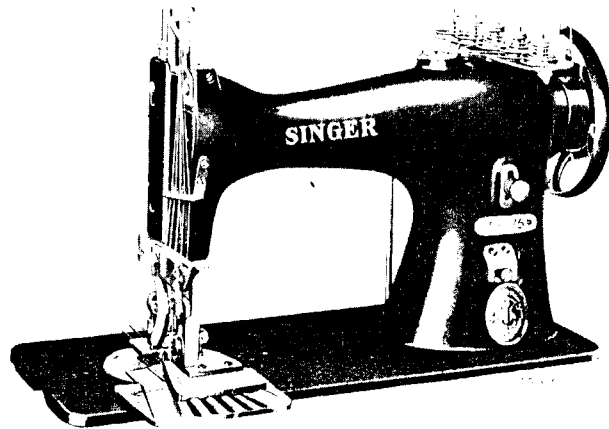

## MACHINE No. 52-75

FIVE NEEDLES, FIVE HOOKS. MAKES FIVE TUCKS

This Machine is the same as 52-55 with Tuck Folding Attachment and the following exceptions:

| NO.   | PLATE | NAME                         |
|-------|-------|------------------------------|
| 13835 | 7458  | Face Plate (lower) .....     |
| 13801 | 7458  | " " (upper) .....            |
| 190b  | 7442  | " " " Screw .....            |
| 47862 | 5408  | Feed Dog .....               |
| 47863 | 5409  | " " .....                    |
| 47877 | 7542  | Presser Foot (hinged) .....  |
| 47897 | 5408  | Throat Plate for 47862 ..... |
| 47898 | 5409  | " " " 47863 .....            |

NOTE:—Tuck Folding Attachments can be furnished for machines in use, but machines must be returned to the factory to be fitted. When parts are required for repairs the sample must accompany the order.

## IRON BASE

| NO.   | PLATE | NAME                                                                                                      |
|-------|-------|-----------------------------------------------------------------------------------------------------------|
| 11118 | 7446  | Bed Frame Cushion (leather) .....                                                                         |
| 7263  | 7446  | " " Hinge Connection (long) .....                                                                         |
| 14098 | 7446  | " " " " (short) .....                                                                                     |
| 14008 | 7446  | " " " " Pin .....                                                                                         |
| 970b  | 7446  | " " Thumb Screw .....                                                                                     |
| 13697 | 1511  | " " with 970b, 2978, 7263, 14098,<br>two 14008 and four each 11118 and<br>wood screws 1¼ in. No. 12 ..... |
| 2978  | 1514  | Drip Pan .....                                                                                            |

## ACCESSORIES

| NO.   | PLATE | NAME                                                                         |
|-------|-------|------------------------------------------------------------------------------|
| 12361 | 7446  | Machine Hinge Connection .....                                               |
| 44139 | 7446  | " " Plate .....                                                              |
| 44140 | —     | Machine Hinge complete, Nos. 12361,<br>44139 and wood screw 1¼ in. No. 14 .. |
| 12405 | 7446  | Machine Rest (felt) .....                                                    |
| 41400 | 7447  | " " Pin (wood) 3¼ in. long ..                                                |
| 36569 | 7447  | Oiler with 36571 .....                                                       |
| 36570 | —     | " 36569, filled with oil .....                                               |
| 36571 | 7447  | " Spout, 1¼ in. long, with 36807 .....                                       |
| 36807 | 7446  | " " Washer (leather) .....                                                   |
| 26026 | 7447  | Screw Driver (large) .....                                                   |
| 26485 | 7447  | " " (small) .....                                                            |
| 35143 | 7447  | Tweczers, 4 in. ....                                                         |
| 8909  | 7447  | Wrench for 1513 and 1518 .....                                               |
| 8908  | 7447  | " " 1519 and 1520 .....                                                      |
| 4822  | 7447  | " " 1521 and 1547 .....                                                      |

## CORDER

FOR MACHINE NO. 52-55

| NO.   | PLATE | NAME                                                                 |
|-------|-------|----------------------------------------------------------------------|
| 28551 | 7464  | Arm with Tip and Cord Guides .....                                   |
| 175b  | 7444  | " Adjusting Screw .....                                              |
| 28554 | 7464  | " Bracket .....                                                      |
| 25790 | 7449  | " Hinge Pin .....                                                    |
| 28556 | 7464  | Arm and Bracket complete, Nos. 175b,<br>25790, 28551 and 28554 ..... |
| 26211 | 5497  | Presser Foot .....                                                   |
| 28562 | —     | Corder complete, Nos. 135b, 26211 and<br>28556 .....                 |

| NO.   | PLATE     | NAME                                                            |
|-------|-----------|-----------------------------------------------------------------|
|       | 135D 7450 | Corder Screw.....                                               |
| 26354 | 1512      | Cord Guide Eyelet for 26356.....                                |
| 26355 | 1512      | " " Plate for 26356.....                                        |
| 26356 | 1512      | Cord Guide (table) complete, Nos. 26355<br>and seven 26354..... |
| 26358 | 1512      | Cord Tension Pin for 26359.....                                 |
| 26357 | 1512      | " " Plate for 26359.....                                        |
| 26359 | 1512      | Cord Tension (bed) complete, Nos. 26357<br>and ten 26358.....   |

## PRESSER FOOT

FOR MACHINE NO. 52-55

| NO.   | PLATE | NAME                                 |
|-------|-------|--------------------------------------|
| 28572 | 5497  | Presser Foot, for group cording..... |

## TAPE HOLDERS

### TAPE HOLDER (5 in. Diam.)

FOR UNDER THE BENCH

| NO.   | PLATE    | NAME                                                                                      |
|-------|----------|-------------------------------------------------------------------------------------------|
| 36795 | —        | Body.....                                                                                 |
| 36796 | —        | Cover.....                                                                                |
|       | 55D 7449 | " Hinge Screw.....                                                                        |
| 28994 | 2116     | Tape Holder complete, Nos. 55D, 36795,<br>36796 and two wood screws 1¼ in.<br>No. 10..... |

### TAPE HOLDER (Straight) 8 in. Disc.

| NO.   | PLATE     | NAME                                                         |
|-------|-----------|--------------------------------------------------------------|
| 26061 | 989       | Bracket Wire with Disc.....                                  |
| 26062 | 989       | Disc (adjustable) with 286D and 35925.....                   |
| 35925 | 7449      | " Hub.....                                                   |
|       | 286D 7450 | " " Thumb Screw.....                                         |
| 26325 | 7448      | Foot with 736D and three wood screws 1 in.<br>No. 12.....    |
|       | 736D 7449 | Thumb Screw.....                                             |
| 26063 | 989       | Tape Holder complete, Nos. 26061 and<br>26062.....           |
| 26065 | —         | Tape Holder with Foot complete, Nos.<br>26063 and 26325..... |
| 234D  | 7449      | Tape Holder Thumb Screw.....                                 |

## TAPE HOLDER (Offset) 10 in. Disc.

| NO.   | PLATE     | NAME                                                             |
|-------|-----------|------------------------------------------------------------------|
| 26066 | 989       | Bracket Wire.....                                                |
| 26067 | —         | Bracket Wire complete, Nos. 26066, 26068<br>and 26072.....       |
| 26068 | 989       | Disc.....                                                        |
| 26069 | 989       | " Hub.....                                                       |
| 26070 | 7446      | " " Rivet..... per 100                                           |
| 26071 | —         | Disc complete, Nos. 26068, 26069 and<br>three 26070.....         |
| 26064 | 7448      | Foot with 736D and three wood screws 1 in.<br>No. 12.....        |
|       | 736D 7449 | Foot Thumb Screw.....                                            |
| 26072 | 989       | Tape Guide.....                                                  |
| 26073 | 7449      | Tension Adjusting Collar with 286D.....                          |
|       | 286D 7450 | " " " Thumb Screw.....                                           |
| 13211 | 7446      | " " Spring.....                                                  |
| 26074 | 989       | Tape Holder complete, Nos. 13211, 26067,<br>26071 and 26073..... |
| 26343 | —         | Tape Holder with Foot complete, Nos.<br>26064 and 26074.....     |

## FOOT LIFTER PARTS

| NO.  | PLATE     | NAME                                                        |
|------|-----------|-------------------------------------------------------------|
| 5596 | 7448      | Bell Crank.....                                             |
| 5599 | 7448      | " " Bracket.....                                            |
|      | 178E 7450 | " " " Screw.....                                            |
| 5601 | 7446      | " " Hinge Pin.....                                          |
| 5735 | 7446      | " " Spring.....                                             |
| 5598 | 7448      | Bell Crank complete, Nos. 5596, 5599,<br>5601 and 5735..... |
| 5670 | —         | Chain, length 26 in. to 35 in.....                          |

NOTE:—When ordering No. 5670 give length required.

|       |           |                                                      |
|-------|-----------|------------------------------------------------------|
| 4879  | 7448      | Chain Connecting Link for 4885.....                  |
| 13587 | 7448      | Lifting Lever.....                                   |
| 13588 | 7448      | " " Connecting Rod.....                              |
| 12416 | 7446      | " " " " Joint.....                                   |
|       | 7D 7446   | " " " " " Hinge<br>Screw.....                        |
| 1521B | 7446      | Lifting Lever Connecting Rod Lock Nut.....           |
|       | 802D 7450 | " " Hinge Screw.....                                 |
| 2763  | 1516      | Rock Shaft.....                                      |
| 12242 | 1516      | " " Hanger with two wood screws<br>1 in. No. 10..... |



| NO.   | PLATE | NAME                                                                                                       |
|-------|-------|------------------------------------------------------------------------------------------------------------|
| 6337  | 1516  | Rock Shaft Lifting Bracket with two 356c.....                                                              |
| 12243 | 1516  | Rock Shaft Lifting Bracket Hook for 4880                                                                   |
| 7125  | 1516  | " " " " " " " "                                                                                            |
| 356c  | 7450  | " " " " " " Set Screw.....                                                                                 |
| 356c  | 7450  | Rock Shaft Lifting Bracket Set Screw....                                                                   |
| 2770  | 1516  | " " Stop Dog with 356c.....                                                                                |
| 356c  | 7450  | " " " " Set Screw.....                                                                                     |
| 4880  | 1516  | Rock Shaft complete, Nos. 2763, 2770, 7125, 12243 and two each 6337 and 12242.....                         |
| 4881  | 1516  | Treadle.....                                                                                               |
| 4882  | 7448  | " Shaft.....                                                                                               |
| 4883  | 7448  | " Spring.....                                                                                              |
| 4884  | 1516  | " Stand.....                                                                                               |
| 4885  | 1516  | Treadle complete, Nos. 4879, 4881 to 4884 and two wood screws 1 in. No. 16.....                            |
| 13725 | —     | Foot Lifter complete, Nos. 76D, 802D, 1521E, 4880, 4885, 5598, 5670, 12416, 13587, 13588 and two 178E..... |

## KNEE LIFTER PARTS

| NO.   | PLATE | NAME                                                     |
|-------|-------|----------------------------------------------------------|
| 5596  | 7448  | Bell Crank.....                                          |
| 5599  | 7448  | " " Bracket.....                                         |
| 178E  | 7450  | " " " Screw.....                                         |
| 5601  | 7446  | " " Hinge Pin.....                                       |
| 5735  | 7446  | " " Spring.....                                          |
| 5598  | 7448  | Bell Crank complete, Nos. 5596, 5599, 5601 and 5735..... |
| 13587 | 7448  | Lifting Lever.....                                       |
| 13588 | 7448  | " " Connecting Rod.....                                  |
| 12416 | 7446  | " " " " Joint.....                                       |
| 76D   | 7446  | " " " " " Hinge Screw.....                               |
| 1521E | 7446  | Lifting Lever Connecting Rod Lock Nut.                   |
| 802D  | 7450  | " " Hinge Screw.....                                     |
| 2763  | 1511  | Rock Shaft.....                                          |
| 12242 | 1511  | " " Hanger with two wood screws 1 in. No. 10.....        |
| 2765  | 1511  | Rock Shaft Knee Arm.....                                 |
| 2766  | 1511  | " " " " Hub with 356c....                                |
| 356c  | 7450  | " " " " " Set Screw....                                  |
| 2768  | —     | Rock Shaft Knee Arm complete, Nos. 2765 to 2767.....     |

| NO.   | PLATE | NAME                                                                                           |
|-------|-------|------------------------------------------------------------------------------------------------|
| 2767  | 1511  | Rock Shaft Knee Plate with 356c.....                                                           |
| 356c  | 7450  | " " " " Set Screw.....                                                                         |
| 6337  | 1511  | " " Lifting Bracket with two 356c                                                              |
| 2778  | 1511  | " " " " Hook.....                                                                              |
| 356c  | 7450  | " " " " " Set Screw.....                                                                       |
| 356c  | 7450  | Rock Shaft Lifting Bracket Set Screw....                                                       |
| 2770  | 1511  | " " Stop Dog with 356c.....                                                                    |
| 356c  | 7450  | " " " " Set Screw.....                                                                         |
| 2777  | 1511  | Rock Shaft complete, Nos. 2763, 2768, 2770, 2778, 6337 and two 12242.....                      |
| 17039 | —     | Knee Lifter complete, Nos. 76D, 802D, 1521E, 2777, 5598, 12416, 13587, 13588 and two 178E..... |

## THREAD UNWINDERS

### THREAD UNWINDER

FOR TWO LARGE SPOOLS OR TWO LARGE CONES OF THREAD

| NO.   | PLATE | NAME                                                                                                                |
|-------|-------|---------------------------------------------------------------------------------------------------------------------|
| 27623 | 2837  | Spool Pin.....                                                                                                      |
| 155c  | 7450  | " " Set Screw.....                                                                                                  |
| 41530 | 2837  | " Rest.....                                                                                                         |
| 41531 | —     | " " 41530 with 1149c and two each 155c and 27623.....                                                               |
| 1149c | 7450  | Spool Rest Set Screw.....                                                                                           |
| 27910 | 2837  | " Stand with 453c.....                                                                                              |
| 41514 | 2837  | " Weight, 4 in. diam., with 11515....                                                                               |
| 41515 | 7446  | " " Centre Pin.....                                                                                                 |
| 27739 | 2837  | Thread Cone (wood).....                                                                                             |
| 41631 | 2837  | " Guard with 208E and two 41569....                                                                                 |
| 41569 | 7446  | " " Eyelet.....                                                                                                     |
| 41637 | 2837  | " " Rod (lower).....                                                                                                |
| 41638 | 2837  | " " (upper).....                                                                                                    |
| 41639 | 2837  | " " " Coupling with two 459c.....                                                                                   |
| 456c  | 7450  | Thread Guard Rod Coupling Set Screw....                                                                             |
| 41640 | —     | Thread Guard Rod complete, 30 in. long, Nos. 41637 to 41639.....                                                    |
| 453c  | 2831  | Thread Guard Rod Set Screw.....                                                                                     |
| 208E  | 7450  | " " Screw.....                                                                                                      |
| 41533 | 2837  | Thread Unwinder complete, Nos. 27910, 41531, 41631, 41640, two each 27739, 41514 and three wood screws 1 in. No. 12 |

## THREAD UNWINDER

### FOR THREE LARGE SPOOLS OR THREE LARGE CONES OF THREAD

This Thread Unwinder is the same as No. 41533 with the following exceptions:

| NO.   | PLATE | NAME                                                                                                                    |
|-------|-------|-------------------------------------------------------------------------------------------------------------------------|
| 41434 | 5571  | Spool Rest, in place of 41530.....                                                                                      |
| 41435 | —     | “ “ 41434 with 1149c and three each 155c and 27623, in place of 41531.                                                  |
| 41632 | 5571  | Thread Guard with 208E and three 41569, in place of 41631.....                                                          |
| 41438 | 5571  | Thread Unwinder complete, Nos. 27940, 41435, 41632, 41640 and three each 27739, 41514 and wood screws 1 in. No. 12..... |

## LIST OF PARTS COMPLETE

FOR

## FEED ROLLS

TO BE USED WITH UNDER DRIVER NO. 27985

| NO.   | PLATE | NAME                                               |
|-------|-------|----------------------------------------------------|
| 27971 | 2830  | Feed Roll (lower) with two 446c.....               |
| 446c  | 2831  | “ “ “ Set Screw.....                               |
| 27972 | 2829  | “ “ “ Shaft.....                                   |
| 11411 | 2831  | “ “ “ “ Collar with 453c.....                      |
| 453c  | 2831  | “ “ “ “ “ Set Screw.....                           |
| 27973 | 2830  | “ “ “ “ Support.....                               |
| 27974 | 2830  | “ “ “ (upper).....                                 |
| 27975 | 2831  | “ “ “ “ Bar.....                                   |
| 6533  | 2831  | “ “ “ “ Collar with 460c.....                      |
| 460c  | 2831  | “ “ “ “ “ Set Screw.....                           |
| 27976 | 2831  | “ “ “ “ Guide Bracket with 454c.....               |
| 454c  | 2831  | Feed Roll (upper) Bar Guide Bracket Set Screw..... |
| 9532  | 2831  | Feed Roll (upper) Bar Lifter with 9533.....        |
| 81b   | 2831  | “ “ “ “ “ Hinge Screw.....                         |
| 9533  | 2831  | “ “ “ “ “ Stop Pin.....                            |
| 2065  | 2831  | “ “ “ “ “ Spring.....                              |
| 27977 | 2830  | “ “ “ “ Bracket with 453c and 910c.....            |
| 910c  | 2831  | Feed Roll (upper) Bracket Set Screw.....           |
| 2932  | 2830  | “ “ “ “ Shaft.....                                 |

| NO.   | PLATE | NAME                                                                                                                             |
|-------|-------|----------------------------------------------------------------------------------------------------------------------------------|
| 453c  | 2831  | Feed Roll (upper) Shaft Set Screw.....                                                                                           |
| 27978 | 2829  | “ “ “ Frame.....                                                                                                                 |
| 27979 | 2829  | “ “ “ Pulley (grooved) 9 $\frac{7}{8}$ in. diam., with 435c.....                                                                 |
| 435c  | 2831  | Feed Roll Pulley (grooved) Set Screw.....                                                                                        |
| 27980 | —     | Feed Rolls complete, Nos. 81b, 2065, 2932, 6533, 9532, 11411, 27971 to 27979 and six wood screws 1 $\frac{1}{4}$ in. No. 12..... |

## UNDER DRIVER

BALL BEARING, LEVER PRESSURE, TWO SPEED, RIGHT HAND.  
TO BE USED WITH FEED ROLLS NO. 27980

| NO.   | PLATE | NAME                                                                                                         |
|-------|-------|--------------------------------------------------------------------------------------------------------------|
| 27750 | 7468  | Cone Pulley (grooved) two speed, 3 $\frac{1}{8}$ in. and 5 $\frac{3}{8}$ in. diam., with 878b and 12459..... |
| 25303 | 2641  | Cone Pulley Ball, size $\frac{1}{4}$ in. .... per 100                                                        |
| 27753 | 2641  | “ “ “ Bearing Adjusting Ring.....                                                                            |
| 1143c | 2641  | “ “ “ “ “ “ “ Set Screw.....                                                                                 |
| 27795 | 2641  | Cone Pulley Ball Bearing Adjusting Ring Set Screw Washer..... per 100                                        |
| 878b  | 2641  | Cone Pulley Oil Hole Stop Screw.....                                                                         |
| 12459 | 2641  | “ “ “ “ “ “ Washer (leather)..... per 100                                                                    |
| 27755 | 7468  | Dress Guard.....                                                                                             |
| 348E  | 2642  | “ “ “ Screw.....                                                                                             |
| 2718  | 2642  | “ “ “ “ Washer.....                                                                                          |
| 27981 | 2829  | Driving Pulley (grooved) 5 $\frac{7}{8}$ in. diam., with 1337c, 7958, 27598 and 27982.....                   |
| 27982 | 2830  | Driving Pulley (grooved) 1 $\frac{1}{2}$ in. diam., with 451c.....                                           |
| 27598 | —     | Driving Pulley Friction Ring (leather).....                                                                  |
| 7958  | 2642  | “ “ “ “ “ Stop Pin.....                                                                                      |
| 1337c | 2831  | “ “ “ “ “ Set Screw for 27981.....                                                                           |
| 451c  | 2831  | “ “ “ “ “ “ 27982.....                                                                                       |
| 27757 | 2641  | “ “ “ “ Shaft.....                                                                                           |
| 25303 | 2641  | “ “ “ “ Ball, size $\frac{1}{4}$ in., ..... per 100                                                          |
| 27751 | 2641  | Driving Pulley Shaft Ball Bearing Collar.....                                                                |
| 27752 | 2641  | “ “ “ “ “ “ “ Pin.....                                                                                       |
| 27758 | 2641  | Driving Pulley Shaft Ball Safety Washer.....                                                                 |
| 27759 | 2641  | “ “ “ “ “ Screw Bearing Ball Case (left).....                                                                |

| NO.   | PLATE | NAME                                                                                                                  |
|-------|-------|-----------------------------------------------------------------------------------------------------------------------|
| 27760 | —     | Driving Pulley Shaft Screw Bearing Ball Case (left) complete, Nos. 27758, 27759, 27761 to 27763 and twelve 25303..... |
| 27761 | 2641  | Driving Pulley Shaft Screw Bearing Ball Case (left) Friction Stud.....                                                |
| 25303 | 2641  | Driving Pulley Shaft Screw Bearing Ball Case (left) Friction Stud Ball, size 1/4 in., .....per 100                    |
| 27762 | 2641  | Driving Pulley Shaft Screw Bearing Ball Case (left) Friction Stud Ball Plate...                                       |
| 27763 | 2641  | Driving Pulley Shaft Screw Bearing Ball Case (left) Friction Stud Ball Plate Washer.....                              |
| 27754 | 2641  | Driving Pulley Shaft Screw Bearing Ball Case (left) Friction Stud Extension Pin                                       |
| 1122c | 2641  | Driving Pulley Shaft Screw Bearing Ball Case (left) Set Screw.....                                                    |
| 27764 | 2641  | Driving Pulley Shaft Screw Bearing Ball Case (right).....                                                             |
| 27765 | —     | Driving Pulley Shaft Screw Bearing Ball Case (right) complete, Nos. 27758, 27764 and eight 25303.....                 |
| 1122c | 2641  | Driving Pulley Shaft Screw Bearing Ball Case (right) Set Screw.....                                                   |
| 27983 | 2829  | Frame with two 1122c.....                                                                                             |
| 27767 | 7468  | Lever with 27768 and two 27878.....                                                                                   |
| 1093c | 2642  | " Adjusting Screw.....                                                                                                |
| 1513j | 2642  | " " Nut.....                                                                                                          |
| 27768 | 2642  | " Brake (leather, two pieces).....                                                                                    |
| 27878 | 2642  | " " Rivet.....                                                                                                        |
| 1092E | 2642  | " Hinge Screw.....                                                                                                    |
| 1507j | 2642  | " " Nut.....                                                                                                          |
| 27769 | 2642  | " Spring.....                                                                                                         |
| 27070 | 1165  | Shaft Driving Pulley (sectional, grooved) 10 in. diam., 1 1/8 in. bore, with two 597c                                 |
| 597c  | 2642  | Shaft Driving Pulley Clamping Screw...                                                                                |
| 27636 | 1165  | Treadle.....                                                                                                          |
| 9082  | 2642  | " Bearing Cotter Pin.....                                                                                             |
| 27637 | 7468  | " Pitman Rod (lower).....                                                                                             |
| 27638 | 2642  | " " " Spring.....                                                                                                     |
| 27639 | 7468  | " " " (upper).....                                                                                                    |
| 9079  | 7468  | " " " Clamp with 354c...                                                                                              |
| 354c  | 2642  | " " " " Screw.....                                                                                                    |
| 27640 | 7468  | Treadle Pitman complete, Nos. 2762, 9079 and 27637 to 27639.....                                                      |
| 2878  | 1165  | Treadle Stand.....                                                                                                    |
| 2762  | 2642  | " Stop Collar with 362F.....                                                                                          |
| 362F  | 2642  | " " " Set Screw.....                                                                                                  |

| NO.   | PLATE | NAME                                                                                                                                                                                                                                     |
|-------|-------|------------------------------------------------------------------------------------------------------------------------------------------------------------------------------------------------------------------------------------------|
| 27642 | —     | Treadle complete, Nos. 2878, 9082, 27636 and four wood screws 1 in. No. 16.....                                                                                                                                                          |
| 27643 | —     | Treadle and Pitman complete, Nos. 27640 and 27642.....                                                                                                                                                                                   |
| 27984 | —     | Transmitter complete, Nos. 348E, 1092E, 1093c, 1507j, 1513j, 2718, 27750 to 27752, 27754, 27755, 27757, 27760, 27765, 27767, 27769, 27981, 27983, two each 1143c, 27753, 27795, three wood screws 2 in. No. 16 and twenty-two 25303..... |
| 27985 | —     | Under Driver (ball bearing) lever pressure, two speed, right hand, complete, Nos. 27070, 27643 and 27984.....                                                                                                                            |

## OBSOLETE PARTS

| NO.   | PLATE | NAME                                                              |
|-------|-------|-------------------------------------------------------------------|
| 13815 | —     | Needle Bar Connecting Stud with 1904 and two 640c, use 13896..... |
| 640c  | 7450  | Needle Bar Connecting Stud Clamping Screw for 13815.....          |

SINGER Needles should be used in SINGER Machines. These Needles and their Containers are marked with the Company's Trade Mark "SIMANCO.\*\*\*" 1

Needles in Containers marked "FOR SINGER MACHINES" are NOT **SINGER** made needles. 2

## NUMERICAL LIST OF PARTS

| NO.  | PLATE | NAME                                                                        |
|------|-------|-----------------------------------------------------------------------------|
| 55d  | 7449  | Tape Holder Cover Hinge Screw for 28994                                     |
| 74E  | 7444  | Feed Regulator Hinge Screw.....                                             |
| 76d  | 7446  | Lifting Lever Connecting Rod Joint<br>Hinge Screw for 13725 and 17039 ..... |
| 81d  | 2831  | Feed Roll (upper) Bar Lifter Hinge Screw<br>for 27980.....                  |
| 135d | 7450  | Corder Screw for 28562.....                                                 |
| 135E | 7450  | Arm Screw (right).....                                                      |
| 144d | 7450  | " Shaft Screw.....                                                          |
| 145E | 7450  | Crank Connecting Rod Cap Screw for<br>13799.....                            |
| 145E | 7450  | Feed Lifting Rock Shaft Connecting Rod<br>Cap Screw for 13808.....          |
| 155c | 7450  | Thread Unwinder Spool Pin Set Screw for<br>41435 and 41531.....             |
| 157j | 7444  | Feed Lifting Rock Shaft Crank Clamping<br>Screw for 2599.....               |
| 175d | 7444  | Corder Arm Adjusting Screw for 28556.....                                   |
| 175E | 7444  | Needle Bar Connecting Stud Clamping<br>Screw for 13896.....                 |
| 175E | 7450  | Bell Crank Bracket Screw for 13725 and<br>17039.....                        |
| 190d | 7442  | Face Plate Screw for 52-55 Machine.....                                     |
| 190d | 7442  | " " (upper) Screw for 52-75<br>Machine.....                                 |
| 190d | 7442  | Presser Foot Screw.....                                                     |
| 190d | 7442  | Thread Controller Post Screw.....                                           |
| 191c | 7450  | Feed Dog Screw.....                                                         |
| 208E | 7450  | Thread Unwinder Thread Guard Screw<br>for 41631 and 41632.....              |
| 210d | 7450  | Balance Wheel Oil Cover Screw.....                                          |
| 217F | 7450  | Looper Carrier Shaft Set Screw for 13811                                    |
| 219d | 7450  | Thread Guide (side of arm) Screw.....                                       |
| 233d | 7442  | " Controller Spring Screw for 13847                                         |
| 237F | 7450  | Looper Carrier Set Screw for 13810.....                                     |
| 263E | 7450  | Pressure Regulating Thumb Screw.....                                        |
| 284d | 7449  | Tape Holder Thumb Screw for 26065.....                                      |
| 286d | 7450  | Arm Side Cover Thumb Screw.....                                             |
| 286d | 7450  | Tape Holder Disc Hub Thumb Screw for<br>26062.....                          |
| 286d | 7450  | Tape Holder Tension Adjusting Collar<br>Thumb Screw for 26073.....          |
| 307c | 7450  | Feed Lifting Rock Shaft Screw Centre...                                     |

| NO.  | PLATE | NAME                                                         |
|------|-------|--------------------------------------------------------------|
| 307c | 7450  | Feed Rock Shaft Screw Centre.....                            |
| 315c | 2642  | " Bar Screw Centre.....                                      |
| 348E | 2642  | Under Driver Dress Guard Screw for<br>27984.....             |
| 354c | 2642  | Under Driver Treadle Pitman Rod Clamp<br>Screw for 9079..... |
| 356c | 7450  | Rock Shaft Knee Arm Hub Set Screw for<br>2766.....           |
| 356c | 7450  | Rock Shaft Knee Plate Set Screw for<br>2767.....             |
| 356c | 7450  | Rock Shaft Lifting Bracket Hook Set<br>Screw for 6337.....   |
| 356c | 7450  | Rock Shaft Lifting Bracket Set Screw for<br>6337.....        |
| 356c | 7450  | Rock Shaft Stop Dog Set Screw for 2770.                      |
| 362F | 2642  | Under Driver Treadle Stop Collar Set<br>Screw for 2762.....  |
| 375c | 7450  | Crank Connecting Rod Hinge Screw.....                        |
| 375c | 7450  | Feed Lifting Rock Shaft Connecting Rod<br>Hinge Screw.....   |
| 378c | 7444  | Feed Connecting Link Hinge Screw (long)                      |
| 378c | 7444  | " Forked Connection Hinge Screw...                           |
| 380c | 7444  | " Connecting Link Hinge Screw (short)                        |
| 435c | 2831  | " Roll Pulley (grooved) Set Screw for<br>27979.....          |
| 435c | 2831  | Needle Bar Crank Set Screw for 13816...                      |
| 443c | 7450  | Arm Shaft Flanged Bushing (front) Set<br>Screw.....          |
| 446c | 2831  | Arm Shaft Flanged Bushing (back) Set<br>Screw.....           |
| 446c | 2831  | Feed Roll (lower) Set Screw for 27971...                     |
| 448c | 7450  | Balance Wheel Set Screw for 13796.....                       |
| 448c | 7450  | Feed and Feed Lifting Eccentric Set Screw<br>for 13803.....  |
| 448c | 7450  | Looper Carrier Shaft Bushing Set Screw.                      |
| 448c | 7450  | Oscillating Rock Shaft Hinge Pin Set<br>Screw.....           |
| 451c | 2831  | Under Driver Driving Pulley Set Screw<br>for 27982.....      |
| 453c | 2831  | Feed Roll (lower) Shaft Collar Set Screw<br>for 11411.....   |
| 453c | 2831  | Feed Roll (upper) Shaft Set Screw for<br>27977.....          |
| 453c | 2831  | Presser Bar Lifting Bracket Set Screw for<br>2953.....       |
| 453c | 2831  | Thread Unwinder Thread Guard Rod Set<br>Screw for 27940..... |

| NO.   | PLATE | NAME                                                                                             |
|-------|-------|--------------------------------------------------------------------------------------------------|
| 454c  | 2831  | Feed Roll (upper) Bar Guide Bracket Set<br>Screw for 27976.....                                  |
| 456c  | 7450  | Thread Unwinder Thread Guard Rod<br>Coupling Set Screw for 41639.....                            |
| 460c  | 2831  | Feed Roll (upper) Bar Collar Set Screw<br>for 6533.....                                          |
| 465c  | 7444  | Feed Rock Shaft Crank Set Screw for<br>2048.....                                                 |
| 597c  | 2642  | Under Driver Shaft Driving Pulley Clamp-<br>ing Screw for 27070.....                             |
| 620F  | 7445  | Needle Set Screw for 13560.....                                                                  |
| 637c  | 7442  | Tension Screw Stud for 13838.....                                                                |
| 640c  | 7450  | Needle Bar Connecting Stud Clamping<br>Screw for 13815, obsolete.....                            |
| 691F  | 7450  | Throat Plate Screw.....                                                                          |
| 736D  | 7449  | Tape Holder Foot Thumb Screw for 26064<br>and 26325.....                                         |
| 747D  | 7444  | Feed Regulator Thumb Screw.....                                                                  |
| 794E  | 7444  | Needle Bar Connecting Link Adjusting<br>Screw for 13582.....                                     |
| 802D  | 7450  | Lifting Lever Hinge Screw for 13725 and<br>17039.....                                            |
| 828c  | 7442  | Tension Screw Stud, for centre tension,<br>for 13838.....                                        |
| 853c  | 7450  | Looper Set Screw for 13810.....                                                                  |
| 878D  | 2641  | Under Driver Cone Pulley Oil Hole Stop<br>Screw for 27750.....                                   |
| 880E  | 7450  | Arm Screw (left).....                                                                            |
| 881c  | 7444  | Needle Bar Connecting Link Hinge Screw                                                           |
| 883B  | 7445  | Thread Take-up Plate Screw.....                                                                  |
| 898D  | 7450  | Arm Oil Tube Bracket Screw.....                                                                  |
| 910c  | 2831  | Feed Roll (upper) Bracket Set Screw for<br>27977.....                                            |
| 970D  | 7446  | Bed Frame Thumb Screw for 13697.....                                                             |
| 1058c | 7445  | Presser Bar Lifter Hinge Screw.....                                                              |
| 1092E | 2642  | Under Driver Lever Hinge Screw for<br>27984.....                                                 |
| 1093c | 2642  | Under Driver Lever Adjusting Screw for<br>27984.....                                             |
| 1122c | 2641  | Under Driver Driving Pulley Shaft Screw<br>Bearing Ball Case (left) Set Screw for<br>27983.....  |
| 1122c | 2641  | Under Driver Driving Pulley Shaft Screw<br>Bearing Ball Case (right) Set Screw for<br>27983..... |
| 1143c | 2641  | Under Driver Cone Pulley Ball Bearing<br>Adjusting Ring Set Screw for 27984...                   |

| NO.   | PLATE | NAME                                                                     |
|-------|-------|--------------------------------------------------------------------------|
| 1149c | 7450  | Thread Unwinder Spool Rest Set Screw for 41435 and 41531.....            |
| 1253c | 7445  | Looper Driving Shaft Crank Set Screw for 13812.....                      |
| 1253c | 7445  | Looper Driving Shaft Link Hinge Pin Set Screw for 13818.....             |
| 1293c | 7450  | Needle Bar Crank Position Screw for 13816.....                           |
| 1337c | 2831  | Under Driver Driving Pulley Set Screw for 27981.....                     |
| 1507j | 2642  | Under Driver Lever Hinge Screw Nut for 27984.....                        |
| 1513j | 2642  | Feed Lifting Rock Shaft Screw Centre Nut.....                            |
| 1513j | 2642  | Feed Rock Shaft Screw Centre Nut.....                                    |
| 1513j | 2642  | Under Driver Lever Adjusting Screw Nut for 27984.....                    |
| 1518E | 7450  | Crank Connecting Rod Hinge Screw Nut                                     |
| 1518E | 7450  | Feed Lifting Rock Shaft Connecting Rod Hinge Screw Nut.....              |
| 1519E | 7450  | Feed Bar Screw Centre Nut.....                                           |
| 1520E | 7444  | " Connecting Link Hinge Screw Nut.....                                   |
| 1520E | 7444  | " Forked Connection Hinge Screw Nut.....                                 |
| 1520E | 7444  | Presser Bar Lifter Hinge Screw Nut.....                                  |
| 1521E | 7446  | Lifting Lever Connecting Rod Lock Nut for 13725 and 17039.....           |
| 1547D | 7442  | Tension Screw Stud Nut for 13838.....                                    |
| 1560c | 7442  | " Regulating Thumb Nut for 13838.....                                    |
| 1813  | 7444  | Feed Lifting Rock Shaft Crank Roller and Stud for 2509.....              |
| 1904  | 7444  | Needle Bar Connecting Stud Roller (roller only) for 13815 and 13896..... |
| 2039  | 7444  | Feed Connecting Link.....                                                |
| 2046  | —     | Feed Rock Shaft complete, Nos. 2047 and 2048.....                        |
| 2047  | 7440  | Feed Rock Shaft for 2046.....                                            |
| 2048  | 7444  | " " " Crank with 465c, for 2046.....                                     |
| 2049  | 7444  | Feed Rock Shaft Crank Pin.....                                           |
| 2058  | 7441  | Presser Bar.....                                                         |
| 2065  | 2831  | Feed Roll (upper) Bar Spring for 27980.....                              |
| 2070  | 7445  | Presser Bar Spring Washer.....                                           |
| 2164  | 7444  | Feed Regulator.....                                                      |
| 2273  | 7445  | Needle Clamp Pin.....                                                    |
| 2509  | 7444  | Feed Lifting Rock Shaft Crank with 1574 and 1813, for 13807.....         |
| 2718  | 2642  | Under Driver Dress Guard Screw Washer for 27984.....                     |

| NO.  | PLATE | NAME                                                                                         |
|------|-------|----------------------------------------------------------------------------------------------|
| 2762 | 2642  | Under Driver Treadle Stop Collar with 362r, for 27640.....                                   |
| 2763 | 1511  | Rock Shaft for 2777 and 4880.....                                                            |
|      |       | Nos. 2765 TO 2767 FOR 2768.                                                                  |
| 2765 | 1511  | Rock Shaft Knee Arm.....                                                                     |
| 2766 | 1511  | " " " " Hub with 356c.....                                                                   |
| 2767 | 1511  | " " " " Plate with 356c.....                                                                 |
| 2768 | —     | Rock Shaft Knee Arm complete for 2777, Nos. 2765 to 2767.....                                |
| 2770 | 1511  | Rock Shaft Stop Dog with 356c, for 2777 and 4880.....                                        |
| 2777 | 1511  | Rock Shaft complete for 17039, Nos. 2763, 2768, 2770, 2778, 6337 and two 12242.....          |
| 2778 | 1511  | Rock Shaft Lifting Bracket Hook for 2777.....                                                |
| 2878 | 1165  | Under Driver Treadle Stand for 27642.....                                                    |
| 2921 | 7442  | Tension Disc for 13838.....                                                                  |
| 2932 | 2830  | Feed Roll (upper) Shaft for 27980.....                                                       |
| 2953 | 7445  | Presser Bar Lifting Bracket with 453c.....                                                   |
| 2978 | 1514  | Drip Pan for 13697.....                                                                      |
| 3100 | 7445  | Presser Bar Spring.....                                                                      |
| 4389 | 7445  | Arm Dowel Pin.....                                                                           |
| 4822 | 7417  | Wrench for 1521 and 1517 (Accessories).....                                                  |
| 4879 | 7448  | Chain Connecting Link for 4885.....                                                          |
| 4880 | 1516  | Rock Shaft complete for 13725, Nos. 2763, 2770, 7125, 12243 and two each 6337 and 12242..... |
|      |       | Nos. 4881 TO 4884 FOR 4885.                                                                  |
| 4881 | 1516  | Treadle.....                                                                                 |
| 4882 | 7448  | " Shaft.....                                                                                 |
| 4883 | 7448  | " Spring.....                                                                                |
| 4884 | 1516  | " Stand.....                                                                                 |
| 4885 | 1516  | Treadle complete for 13725, Nos. 4879, 4881 to 4884 and two wood screws 1 in. No. 16.....    |
| 5596 | 7448  | Bell Crank for 5598.....                                                                     |
| 5598 | 7448  | Bell Crank complete for 13725 and 17039, Nos. 5596, 5599, 5601 and 5735.....                 |
| 5599 | 7448  | Bell Crank Bracket for 5598.....                                                             |
| 5601 | 7446  | " " Hinge Pin for 5598.....                                                                  |
| 5670 | —     | Chain, length 26 in. to 35 in., for 13725.....                                               |
| 5735 | 7446  | Bell Crank Spring for 5598.....                                                              |
| 6337 | 1511  | Rock Shaft Lifting Bracket with two 356c, for 2777 and 4880.....                             |
| 6533 | 2831  | Feed Roll (upper) Bar Collar with 460c, for 27980.....                                       |
| 7125 | 1516  | Rock Shaft Lifting Bracket Hook for 4880.....                                                |

| NO.   | PLATE | NAME                                                                                                                 |
|-------|-------|----------------------------------------------------------------------------------------------------------------------|
| 7263  | 7446  | Bed Frame Hinge Connection (long) for 13697.....                                                                     |
| 7958  | 2642  | Under Driver Driving Pulley Friction Ring Stop Pin for 27981.....                                                    |
| 8908  | 7447  | Wrench for 1519 and 1520 (Accessories)...                                                                            |
| 8909  | 7447  | " " 1513 and 1518 (Accessories)...                                                                                   |
| 9079  | 7468  | Under Driver Treadle Pitman Rod Clamp with 354c, for 27640.....                                                      |
| 9082  | 2642  | Under Driver Treadle Bearing Cotter Pin for 27642.....                                                               |
| 9532  | 2831  | Feed Roll (upper) Bar Lifter with 9533, for 27980.....                                                               |
| 9533  | 2831  | Feed Roll (upper) Bar Lifter Stop Pin for 9532.....                                                                  |
| 11118 | 7446  | Bed Frame Cushion (leather) for 13697...                                                                             |
| 11411 | 2831  | Feed Roll (lower) Shaft Collar with 453c, for 27980.....                                                             |
| 12242 | 1516  | Rock Shaft Hanger with two wood screws 1 in. No. 10, for 2777 and 4880.....                                          |
| 12243 | 1516  | Rock Shaft Lifting Bracket Hook for 4880.....                                                                        |
| 12361 | 7446  | Machine Hinge Connection for 41140.....                                                                              |
| 12405 | 7446  | " Rest, felt (Accessories).....                                                                                      |
| 12416 | 7446  | Lifting Lever Connecting Rod Joint for 13725 and 17039.....                                                          |
| 12459 | 2641  | Under Driver Cone Pulley Oil Hole Stop Screw Washer (leather) for 27750, ..... per 100                               |
| 13211 | 7446  | Tape Holder Tension Adjusting Spring for 26074.....                                                                  |
| 13516 | 7445  | Looper Carrier Shaft.....                                                                                            |
| 13560 | 7461  | Needle Clamp with five 620F or 50014F, for $\frac{1}{8}$ in. to $\frac{1}{4}$ in. gauge.....                         |
| 13581 | 7441  | Needle Bar (hollow).....                                                                                             |
| 13582 | 7444  | " " Connecting Link with 794E... ..                                                                                  |
| 13587 | 7448  | Lifting Lever for 13725 and 17039.....                                                                               |
| 13588 | 7448  | " " Connecting Rod for 13725 and 17039.....                                                                          |
| 13589 | 7442  | Tension Disc Steady Pin for 13837.....                                                                               |
| 13589 | 7442  | " Thread Guide Pin for 13837.....                                                                                    |
| 13594 | 7445  | Thread Take-up Plate.....                                                                                            |
| 13635 | 1514  | Drip Pan with four 1 in. wire nails.....                                                                             |
| 13697 | 1511  | Bed Frame with 970b, 2978, 7263, 14098, two 14008 and four each 11118 and wood screws $1\frac{1}{4}$ in. No. 12..... |
| 13710 | 7442  | Tension Spring for 13838.....                                                                                        |
| 13725 | —     | Foot Lifter complete, Nos. 76b, 802b, 1521E, 4880, 4885, 5598, 5670, 12416, 13587, 13588 and two 178E.....           |

| NO.            | PLATE | NAME                                                                        |
|----------------|-------|-----------------------------------------------------------------------------|
| *13789         | —     | Arm.....                                                                    |
| 13790 to 13792 | —     | Nos. cancelled.                                                             |
| 13793          | 7440  | Arm Shaft.....                                                              |
| 13794          | 7440  | " " Flanged Bushing (back).....                                             |
| 13795          | 7440  | " " " " (front).....                                                        |
| 13796          | 7441  | Balance Wheel, $2\frac{3}{16}$ in. pulley, with two 448c.....               |
| 13797          | 7441  | Balance Wheel Oil Cover.....                                                |
| *13798         | —     | Bed.....                                                                    |
| 13799          | 7441  | Crank Connecting Rod with 13800 and two 145E.....                           |
| *13800         | —     | Crank Connecting Rod Cap for 13799.....                                     |
| 13801          | 7458  | Face Plate (upper) for 52-75 Machine....                                    |
| 13802          | 7443  | Feed Bar.....                                                               |
| 13803          | 7444  | " and Feed Lifting Eccentric with 448c.....                                 |
| 13804          | 7444  | Feed and Feed Lifting Eccentric Sleeve..                                    |
| 13805          | 7440  | " Forked Connection.....                                                    |
| 13806          | 7440  | " Lifting Rock Shaft for 13807.....                                         |
| 13807          | —     | Feed Lifting Rock Shaft complete, Nos. 2509 and 13806.....                  |
| 13808          | 7440  | Feed Lifting Rock Shaft Connecting Rod with 43977 and two 145E.....         |
| 13809          | 7445  | Looper.....                                                                 |
| 13810          | 7461  | " Carrier with two 237F and five 853c.....                                  |
| 13811          | 7441  | Looper Driving Shaft with 217F.....                                         |
| 13812          | 7445  | " " " Crank with two 1253c.....                                             |
| 13813          | 7445  | Looper Driving Shaft Link.....                                              |
| 13814          | 7445  | " " " Hinge Pin....                                                         |
| 13815          | —     | Needle Bar Connecting Stud with 1904 and two 640c, obsolete, use 13896..... |
| 13816          | 7440  | Needle Bar Crank with 435c and 1293c..                                      |
| 13817          | 7461  | " Clamp with five 50014F, for $\frac{3}{8}$ in. gauge and above.....        |
| 13818          | 7445  | Oscillating Rock Shaft with 1253c.....                                      |
| 13819          | 7445  | " " " Hinge Pin.....                                                        |
| 13820          | 7445  | " " " " Bushing.....                                                        |
| 13821 to 13830 | —     | Nos. cancelled.                                                             |
|                |       | Nos. 13831 to 13833 for 13834.                                              |
| 13831          | 7442  | Arm Oil Tube (left) with 49092, for oiling 13811.....                       |
| 13832          | 7442  | Arm Oil Tube (right) with 49092, for oiling 13813.....                      |
| 13833          | —     | Arm Oil Tube Bracket.....                                                   |
| 13834          | 7442  | " " " " 13833 with 13831 and 13832.....                                     |

| NO.   | PLATE | NAME                                                                                                                                      |
|-------|-------|-------------------------------------------------------------------------------------------------------------------------------------------|
| 13835 | 7458  | Face Plate (lower) for 52-75 Machine....                                                                                                  |
| 13836 | 7445  | Looper Carrier Shaft Bushing.....                                                                                                         |
| 13837 | 7460  | Tension Bracket with nine 13589, for<br>13838.....                                                                                        |
| 13838 | —     | Tension Bracket complete, Nos. 828c,<br>13837, four each 637c, 1547d, five each<br>1560c, 13710 and ten 2921.....                         |
| 13839 | —     | Thread Guide (back of arm) six holes, for<br>13840.....                                                                                   |
| 13840 | 7462  | Thread Guide (back of arm) 13839 with<br>13862.....                                                                                       |
| 13841 | 7461  | Thread Guide (side of arm) five holes....                                                                                                 |
| 13842 | —     | " " (top of arm) six holes, for<br>13843.....                                                                                             |
| 13843 | 7463  | Thread Guide (top of arm) 13842 with<br>13862.....                                                                                        |
| 13844 | 7442  | Thread Controller Post for 13847.....                                                                                                     |
| 13845 | 7442  | " " Spring for 13847.....                                                                                                                 |
| 13846 | 7442  | " " Thread Guide.....                                                                                                                     |
| 13847 | —     | Thread Controller complete, Nos. 233b,<br>13844 and 13845.....                                                                            |
| 13849 | 7441  | Face Plate for 52-55 Machine.....                                                                                                         |
| 13862 | 7442  | Arm Oil Tube with 29599, for oiling 13799<br>and 13804, for 13840 and 13843.....                                                          |
| 13896 | 7444  | Needle Bar Connecting Stud with 1904<br>and two 175E.....                                                                                 |
| 14008 | 7446  | Bed Frame Hinge Connection Pin for<br>13697.....                                                                                          |
| 14098 | 7446  | Bed Frame Hinge Connection (short) for<br>13697.....                                                                                      |
| 15196 | 7441  | Arm Side Cover.....                                                                                                                       |
| 17039 | —     | Knee Lifter complete, Nos. 76b, 802b,<br>1521E, 2777, 5598, 12416, 13587, 13588<br>and two 178E.....                                      |
| 21350 | 7444  | Feed Regulator Thumb Screw Stop....                                                                                                       |
| 25303 | 2641  | Under Driver Cone Pulley Ball, size $\frac{1}{4}$ in.,<br>for 27984..... per 100                                                          |
| 25303 | 2641  | Under Driver Driving Pulley Shaft Ball,<br>size $\frac{1}{4}$ in., for 27760 and 27765... per 100                                         |
| 25303 | 2641  | Under Driver Driving Pulley Shaft Screw<br>Bearing Ball Case (left) Friction Stud<br>Ball, size $\frac{1}{4}$ in., for 27760..... per 100 |
| 25790 | 7449  | Corder Arm Hinge Pin for 28556.....                                                                                                       |
| 26026 | 7447  | Screw Driver, large (Accessories).....                                                                                                    |
| 26061 | 989   | Tape Holder Bracket Wire with Disc for<br>26063.....                                                                                      |
| 26062 | 989   | Tape Holder Disc (adjustable) with 286d<br>and 35925, for 26063.....                                                                      |

| NO.   | PLATE | NAME                                                                                                                              |
|-------|-------|-----------------------------------------------------------------------------------------------------------------------------------|
| 26063 | 989   | Tape Holder (straight) 8 in. disc, complete<br>for 26065, Nos. 26061 and 26062.....                                               |
| 26064 | 7448  | Tape Holder Foot with 736d and three<br>wood screws 1 in. No. 12, for 26343.....                                                  |
| 26065 | —     | Tape Holder with Foot complete, Nos.<br>26063 and 26325.....                                                                      |
| 26066 | 989   | Tape Holder Bracket Wire for 26067.....                                                                                           |
| 26067 | —     | Tape Holder Bracket Wire complete for<br>26074, Nos. 26066, 26068 and 26072... ..                                                 |
| 26068 | 989   | Tape Holder Disc for 26067 and 26071... ..                                                                                        |
| 26069 | 989   | " " " Hub for 26071.....                                                                                                          |
| 26070 | 7446  | " " " " Rivet for 26071,<br>..... per 100                                                                                         |
| 26071 | —     | Tape Holder Disc complete for 26074, Nos.<br>26068, 26069 and three 26070.....                                                    |
| 26072 | 989   | Tape Holder Tape Guide for 26067.....                                                                                             |
| 26073 | 7449  | " " Adjusting Collar with 286d,<br>for 26074.....                                                                                 |
| 26074 | 989   | Tape Holder (offset) 10 in. disc, complete<br>for 26343, Nos. 13211, 26067, 26071 and<br>26073.....                               |
| 26211 | 5497  | Presser Foot for 28562.....                                                                                                       |
| 26325 | 7448  | Tape Holder Foot with 736d and three<br>wood screws 1 in. No. 12, for 26065....                                                   |
| 26343 | —     | Tape Holder with Foot complete, Nos.<br>26064 and 26074.....                                                                      |
| 26354 | 1512  | Corder Cord Guide Eyelet for 26356.....                                                                                           |
| 26355 | 1512  | " " " Plate for 26356.....                                                                                                        |
| 26356 | 1512  | Corder Cord Guide (table) complete for<br>52-55 Machine, Nos. 26355 and seven<br>26354.....                                       |
| 26357 | 1512  | Corder Cord Tension Plate for 26359....                                                                                           |
| 26358 | 1512  | " " " Pin for 26359.....                                                                                                          |
| 26359 | 1512  | Corder Cord Tension (bed) complete for<br>52-55 Machine, Nos. 26357 and ten<br>26358.....                                         |
| 26485 | 7447  | Screw Driver, small (Accessories).....                                                                                            |
| 27070 | 1165  | Under Driver Shaft Driving Pulley<br>(sectional, grooved) 10 in. diam., $1\frac{1}{8}$ in.<br>bore, with two 597c, for 27985..... |
| 27598 | —     | Under Driver Driving Pulley Friction<br>Ring (leather) for 27981.....                                                             |
| 27623 | 2837  | Thread Unwinder Spool Pin for 41435<br>and 41531.....                                                                             |
| 27636 | 1165  | Under Driver Treadle for 27642.....                                                                                               |
|       |       | Nos. 27637 to 27639 for 27640.                                                                                                    |
| 27637 | 7468  | Under Driver Treadle Pitman Rod (lower)                                                                                           |



| NO.   | PLATE | NAME                                                                                                                                         |
|-------|-------|----------------------------------------------------------------------------------------------------------------------------------------------|
| 27638 | 2642  | Under Driver Treadle Pitman Rod (lower) Spring.....                                                                                          |
| 27639 | 7468  | Under Driver Treadle Pitman Rod (upper)                                                                                                      |
| 27640 | 7468  | Under Driver Treadle Pitman complete for 27643, Nos. 2762, 9079 and 27637 to 27639.....                                                      |
| 27642 | —     | Under Driver Treadle complete for 27643, Nos. 2878, 9082, 27636 and four wood screws 1 in. No. 16.....                                       |
| 27643 | —     | Under Driver Treadle and Pitman complete for 27985, Nos. 27640 and 27642.                                                                    |
| 27739 | 2837  | Thread Unwinder Thread Cone (wood) for 41438 and 41533.....                                                                                  |
|       |       | Nos. 27750 TO 27755 FOR 27984.                                                                                                               |
| 27750 | 7468  | Under Driver Cone Pulley (grooved) two speed, $3\frac{1}{8}$ in. and $5\frac{3}{8}$ in. diam., with 878D and 12459.....                      |
| 27751 | 2641  | Under Driver Driving Pulley Shaft Ball Bearing Collar.....                                                                                   |
| 27752 | 2641  | Under Driver Driving Pulley Shaft Ball Bearing Collar Pin.....                                                                               |
| 27753 | 2641  | Under Driver Cone Pulley Ball Bearing Adjusting Ring.....                                                                                    |
| 27754 | 2641  | Under Driver Driving Pulley Shaft Screw Bearing Ball Case (left) Friction Stud Extension Pin.....                                            |
| 27755 | 7468  | Under Driver Dress Guard.....                                                                                                                |
| 27757 | 2641  | “ “ Driving Pulley Shaft for 27984.....                                                                                                      |
| 27758 | 2641  | Under Driver Driving Pulley Shaft Ball Safety Washer for 27760 and 27765....                                                                 |
| 27759 | 2641  | Under Driver Driving Pulley Shaft Screw Bearing Ball Case (left) for 27760.....                                                              |
| 27760 | —     | Under Driver Driving Pulley Shaft Screw Bearing Ball Case (left) complete for 27984, Nos. 27758, 27759, 27761 to 27763 and twelve 25303..... |
|       |       | Nos. 27761 TO 27763 FOR 27760.                                                                                                               |
| 27761 | 2641  | Under Driver Driving Pulley Shaft Screw Bearing Ball Case (left) Friction Stud.                                                              |
| 27762 | 2641  | Under Driver Driving Pulley Shaft Screw Bearing Ball Case (left) Friction Stud Ball Plate.....                                               |
| 27763 | 2641  | Under Driver Driving Pulley Shaft Screw Bearing Ball Case (left) Friction Stud Ball Plate Washer.....                                        |

| NO.   | PLATE | NAME                                                                                                                                                                                                                                                            |
|-------|-------|-----------------------------------------------------------------------------------------------------------------------------------------------------------------------------------------------------------------------------------------------------------------|
| 27764 | 2641  | Under Driver Driving Pulley Shaft Screw Bearing Ball Case (right) for 27765....                                                                                                                                                                                 |
| 27765 | —     | Under Driver Driving Pulley Shaft Screw Bearing Ball Case (right) complete for 27984, Nos. 27758, 27764 and eight 25303.....                                                                                                                                    |
| 27767 | 7468  | Under Driver Lever with 27768 and two 27878, for 27984.....                                                                                                                                                                                                     |
| 27768 | 2642  | Under Driver Lever Brake (leather, two pieces) for 27767.....                                                                                                                                                                                                   |
| 27769 | 2642  | Under Driver Lever Spring for 27984....                                                                                                                                                                                                                         |
| 27795 | 2641  | “ “ Cone Pulley Ball Bearing Adjusting Ring Set Screw Washer for 27984.....per 100                                                                                                                                                                              |
| 27878 | 2642  | Under Driver Lever Brake Rivet for 27767                                                                                                                                                                                                                        |
| 27940 | 2837  | Thread Unwinder Spool Stand with 453c, for 41438 and 41533.....                                                                                                                                                                                                 |
|       |       | Nos. 27971 TO 27979 FOR 27980.                                                                                                                                                                                                                                  |
| 27971 | 2830  | Feed Roll (lower) with two 446c.....                                                                                                                                                                                                                            |
| 27972 | 2829  | “ “ “ Shaft.....                                                                                                                                                                                                                                                |
| 27973 | 2830  | “ “ “ “ Support.....                                                                                                                                                                                                                                            |
| 27974 | 2830  | “ “ (upper).....                                                                                                                                                                                                                                                |
| 27975 | 2831  | “ “ “ Bar.....                                                                                                                                                                                                                                                  |
| 27976 | 2831  | “ “ “ “ Guide Bracket with 454c.....                                                                                                                                                                                                                            |
| 27977 | 2830  | Feed Roll (upper) Bracket with 453c and 910c.....                                                                                                                                                                                                               |
| 27978 | 2829  | Feed Roll Frame.....                                                                                                                                                                                                                                            |
| 27979 | 2829  | “ “ Pulley (grooved) $9\frac{7}{8}$ in. diam., with 435c.....                                                                                                                                                                                                   |
| 27980 | —     | Feed Rolls complete for 27985, Nos. 81D, 2065, 2932, 6533, 9532, 11411, 27971 to 27979 and six wood screws $1\frac{1}{4}$ in. No. 12                                                                                                                            |
| 27981 | 2829  | Under Driver Driving Pulley (grooved) $5\frac{7}{8}$ in. diam., with 1337c, 7958, 27598 and 27982, for 27984.....                                                                                                                                               |
| 27982 | 2830  | Under Driver Driving Pulley (grooved) $1\frac{1}{2}$ in. diam., with 451c, for 27981....                                                                                                                                                                        |
| 27983 | 2829  | Under Driver Frame with two 1122c, for 27984.....                                                                                                                                                                                                               |
| 27984 | —     | Under Driver Transmitter complete for 27985, Nos. 348E, 1092E, 1093c, 1507I, 1513I, 2718, 27750 to 27752, 27754, 27755, 27757, 27760, 27765, 27767, 27769, 27981, 27983, two each 1143c, 27753, 27795, three wood screws 2 in. No. 16 and twenty-two 25303..... |

| NO.                                    | PLATE | NAME                                                                                                                                                                                                                              |
|----------------------------------------|-------|-----------------------------------------------------------------------------------------------------------------------------------------------------------------------------------------------------------------------------------|
| 27985                                  | —     | Under Driver (ball bearing) lever pressure, two speed, right hand, complete, Nos. 27070, 27643 and 27984.                                                                                                                         |
| 28551                                  | 7464  | Corder Arm with Tip and Cord Guide for 28556.                                                                                                                                                                                     |
| 28554                                  | 7464  | Corder Arm Bracket for 28556.                                                                                                                                                                                                     |
| 28556                                  | 7464  | Corder Arm and Bracket complete for 28562, Nos. 175D, 25790, 28551 and 28554.                                                                                                                                                     |
| 28562                                  | —     | Corder complete for 52-55 Machine, Nos. 135D, 26211 and 28556.                                                                                                                                                                    |
| 28572                                  | 5497  | Presser Foot, for group cording, for 52-55 Machine.                                                                                                                                                                               |
| 28994                                  | 2116  | Tape Holder (5 in. diam.) complete, for under the bench, Nos. 55D, 36795, 36796 and two wood screws 1¼ in. No. 10.                                                                                                                |
| 29599                                  | 7442  | Arm Oil Tube Packing (felt) for 13862, per 100                                                                                                                                                                                    |
| Nos. 30341 TO 30355 FOR 52-55 MACHINE. |       |                                                                                                                                                                                                                                   |
| 30341                                  | 4684  | Presser Foot (tube) for two strips, for reeding.                                                                                                                                                                                  |
| 30342                                  | 4684  | Presser Foot (tube) for reeding.                                                                                                                                                                                                  |
| 30343                                  | 5498  | " " for strip cording, with guides for upper and under strips.                                                                                                                                                                    |
| 30344                                  | 4685  | Presser Foot, for braiding.                                                                                                                                                                                                       |
| 30345                                  | 5499  | " " " general work.                                                                                                                                                                                                               |
| 30346                                  | 5498  | " " (tube).                                                                                                                                                                                                                       |
| 30347                                  | —     | No. cancelled, order 30342.                                                                                                                                                                                                       |
| 30348                                  | 4685  | Presser Foot (hinged, tube) for reeding between the second needle from the right hand side and the centre needle, leaving out the first needle from the right hand side and the first and second needles from the left hand side. |
| 30349                                  | 4686  | Presser Foot (hinged, tube) for reeding between the second and centre needles from the right hand side and the second and centre needles from the left hand side.                                                                 |
| 30350                                  | 4686  | Presser Foot (hinged, tube) for reeding, leaving out the first needle from the right hand side.                                                                                                                                   |
| 30351                                  | 4687  | Presser Foot (hinged, tube) for reeding between the first and second needles from the right hand side and the first and second needles from the left hand side with centre space for steel, leaving out the centre needle.        |
| 30352                                  | 5497  | Presser Foot, for top and bottom cording.                                                                                                                                                                                         |

| NO.                                    | PLATE | NAME                                                                                                                                                                                  |
|----------------------------------------|-------|---------------------------------------------------------------------------------------------------------------------------------------------------------------------------------------|
| 30353                                  | 4687  | Presser Foot, for cording, with guide for upper strip and two cord tubes.                                                                                                             |
| 30354                                  | 3034  | Presser Foot (strip folding) with six cord tubes.                                                                                                                                     |
| 30355                                  | 3034  | Presser Foot, for strip folding with guides for upper and under strips and two cord tubes.                                                                                            |
| Nos. 31131 TO 31138 FOR 52-55 MACHINE. |       |                                                                                                                                                                                       |
| 31131                                  | 3035  | Presser Foot, for strip folding, with four cord tubes.                                                                                                                                |
| 31132                                  | 3035  | Presser Foot (strip folding) with three cord tubes, leaving out the first needle from the right hand side.                                                                            |
| 31133                                  | 3036  | Presser Foot (strip folding) with five cord tubes, leaving out the first needle from the right hand side.                                                                             |
| 31134                                  | 3036  | Presser Foot, for strip cording, with guides for upper and under strips, leaving out the first needle from the right hand side.                                                       |
| 31135                                  | 3037  | Presser Foot, for general work, leaving out the first needle from the right hand side.                                                                                                |
| 31136                                  | 3037  | Presser Foot, for gathering.                                                                                                                                                          |
| 31137                                  | 3038  | " " (side hinged) for general work.                                                                                                                                                   |
| 31138                                  | 3038  | Presser Foot (strip folding).                                                                                                                                                         |
| Nos. 31140 TO 31142 FOR 52-55 MACHINE. |       |                                                                                                                                                                                       |
| 31140                                  | 3093  | Presser Foot (strip folding) with two cord tubes, for cording between the first and second needles from the right hand side and the first and second needles from the left hand side. |
| 31141                                  | 3093  | Presser Foot (strip folding) for covering two cords with two strips, leaving out the centre needle.                                                                                   |
| 31142                                  | 3094  | Presser Foot, for gathering, leaving out the first needle from the right hand side.                                                                                                   |
| 31144                                  | 3095  | Presser Foot (strip folding) with interlining guide, leaving out the first needle from the right hand side, for 52-55 Machine.                                                        |
| 31145                                  | 3096  | Presser Foot (strip folding) with interlining guide, for 52-55 Machine.                                                                                                               |
| Nos. 31147 TO 31151 FOR 52-55 MACHINE. |       |                                                                                                                                                                                       |
| 31147                                  | 3094  | Presser Foot (strip folding) leaving out the centre needle, the first needle from the right hand side and the second needle from the left hand side.                                  |

| NO.    | PLATE | NAME                                                                         |
|--------|-------|------------------------------------------------------------------------------|
| 48008  | 5406  | Feed Dog, for gathering and underbraiding                                    |
| 48009  | 5407  | " "                                                                          |
| 48022  | 5400  | Throat Plate for 48002                                                       |
| 48023  | 5401  | " " " 48003                                                                  |
| 48024  | 5402  | " " " 48004                                                                  |
| 48025  | 5403  | " " " 48005, for under strip                                                 |
| 48026  | 5404  | " " " 48006                                                                  |
| 48027  | 5405  | " " " 48007                                                                  |
| 48028  | 5406  | " " " 48008, for gathering and underbraiding                                 |
| 48029  | 5407  | Throat Plate for 48009                                                       |
| 49092  | 7442  | Arm Oil Tube Packing (felt) for 13831 and 13832                              |
| 50014F | 7445  | Needle Set Screw, for $\frac{3}{8}$ in. gauge and above, for 13560 and 13817 |
| 50062J | 7450  | Thread Guide (top of arm) Screw                                              |
| 52016  | 7445  | Presser Bar Lifter                                                           |
| 54897  | 7442  | Arm Oil Cup                                                                  |
| 56006  | 7442  | " Shaft Flanged Bushing (back) Oil Pad (braided cotton)                      |
| 56006  | 7442  | Arm Shaft Flanged Bushing (front) Oil Pad (braided cotton)                   |

SINGER Needles should be used  
in SINGER Machines.  
These Needles and their Containers  
are marked with the  
Company's Trade Mark "SIMANCO." 1

Needles in Containers marked  
"FOR SINGER MACHINES"  
are NOT **SINGER** made needles. 2

## ILLUSTRATIONS OF PARTS

PLATE 989—ONE-FOURTH SIZE

|        |        |        |        |        |        |        |        |        |        |        |        |        |        |        |        |        |        |        |        |        |        |        |        |        |        |        |        |        |        |        |        |        |        |        |        |       |
|--------|--------|--------|--------|--------|--------|--------|--------|--------|--------|--------|--------|--------|--------|--------|--------|--------|--------|--------|--------|--------|--------|--------|--------|--------|--------|--------|--------|--------|--------|--------|--------|--------|--------|--------|--------|-------|
| 26063  | 26064  | 26065  | 26066  | 26067  | 26068  | 26069  | 26070  | 26071  | 26072  | 26073  | 26074  | 26075  | 26076  | 26077  | 26078  | 26079  | 26080  | 26081  | 26082  | 26083  | 26084  | 26085  | 26086  | 26087  | 26088  | 26089  | 26090  | 26091  | 26092  | 26093  | 26094  | 26095  | 26096  | 26097  | 26098  | 26099 |
| Needle | Needle | Needle | Needle | Needle | Needle | Needle | Needle | Needle | Needle | Needle | Needle | Needle | Needle | Needle | Needle | Needle | Needle | Needle | Needle | Needle | Needle | Needle | Needle | Needle | Needle | Needle | Needle | Needle | Needle | Needle | Needle | Needle | Needle | Needle | Needle |       |

ILLUSTRATIONS  
 OF  
 PARTS

SINGER SEWING MACHINE  
 PARTS LIST  
 No. 101

Needle No. 101  
 Size No. 101



26062



26061

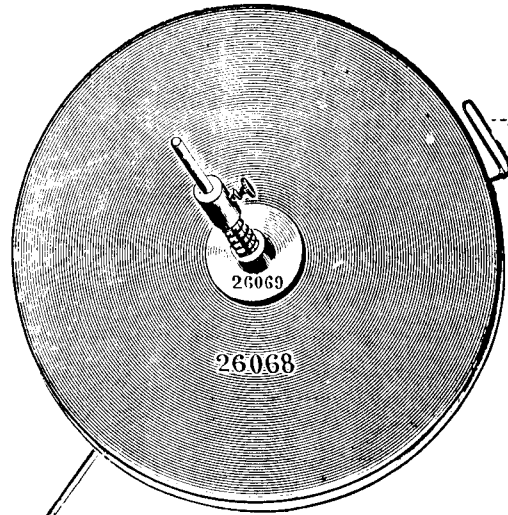

26074

26069

26068

26072

26068

From the library of: Diamond Needle Corp

PLATE 1165—ONE-FOURTH SIZE

27070

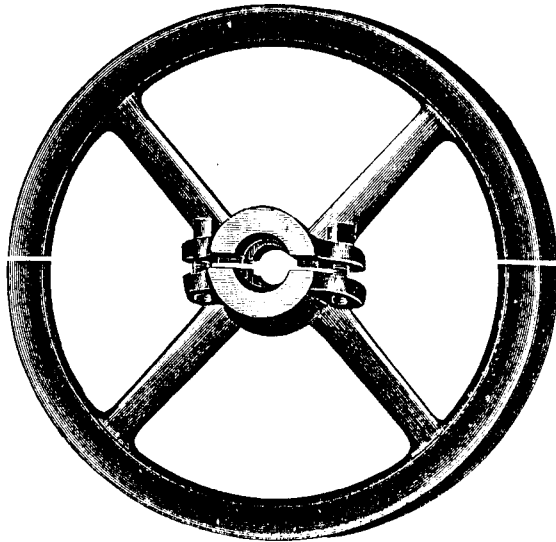

2878



27636

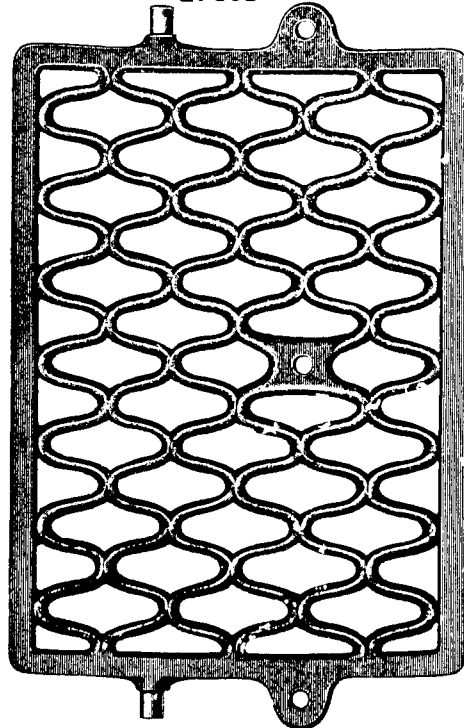

PLATE 1511—ONE-FOURTH SIZE

13697

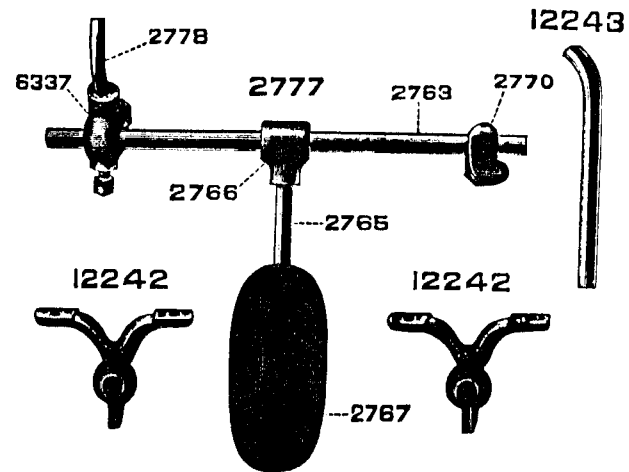
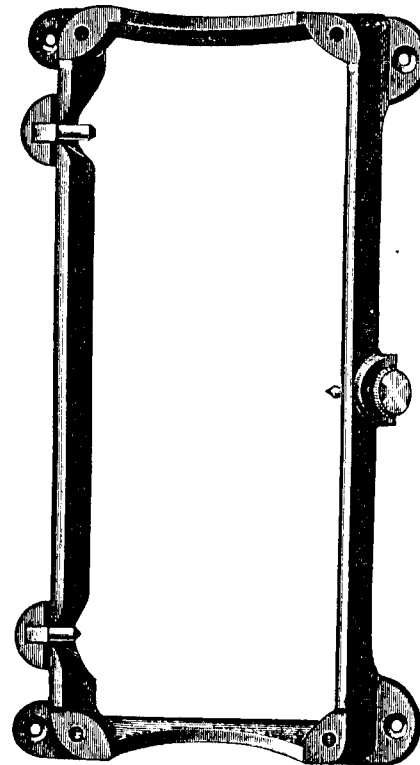

PLATE 1512—FULL SIZE

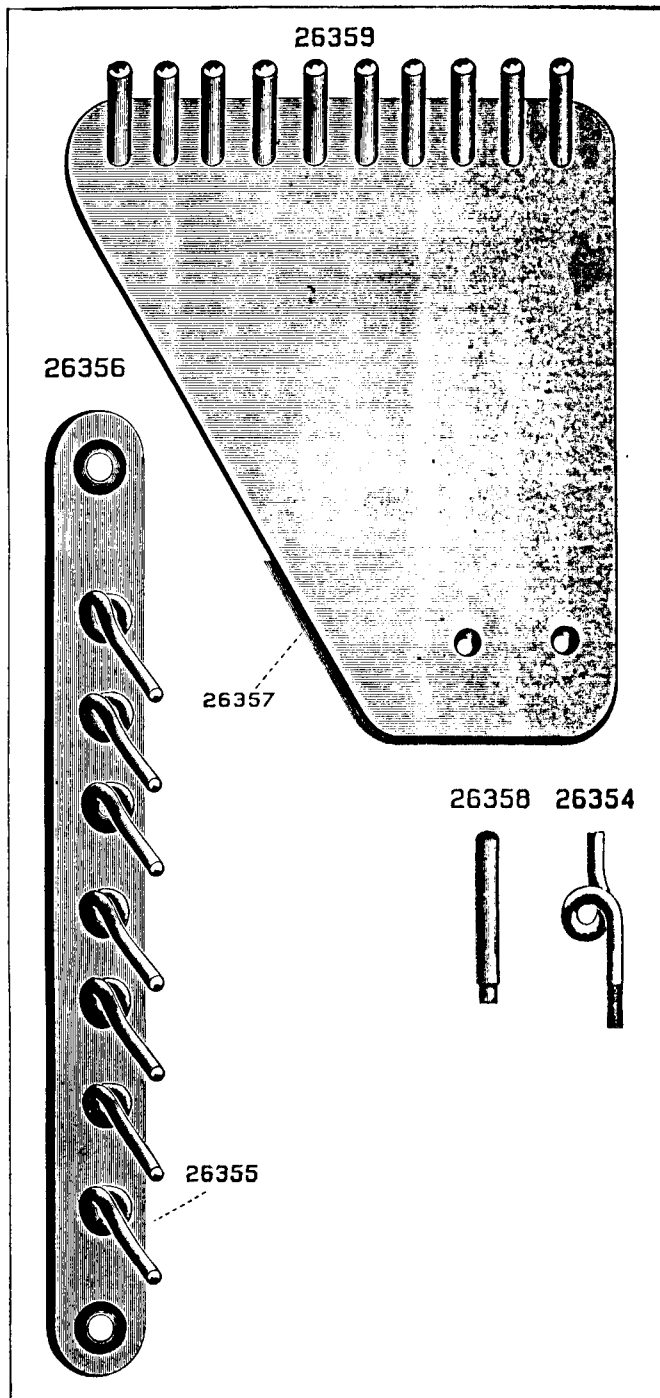

PLATE 1514—ONE-FOURTH SIZE

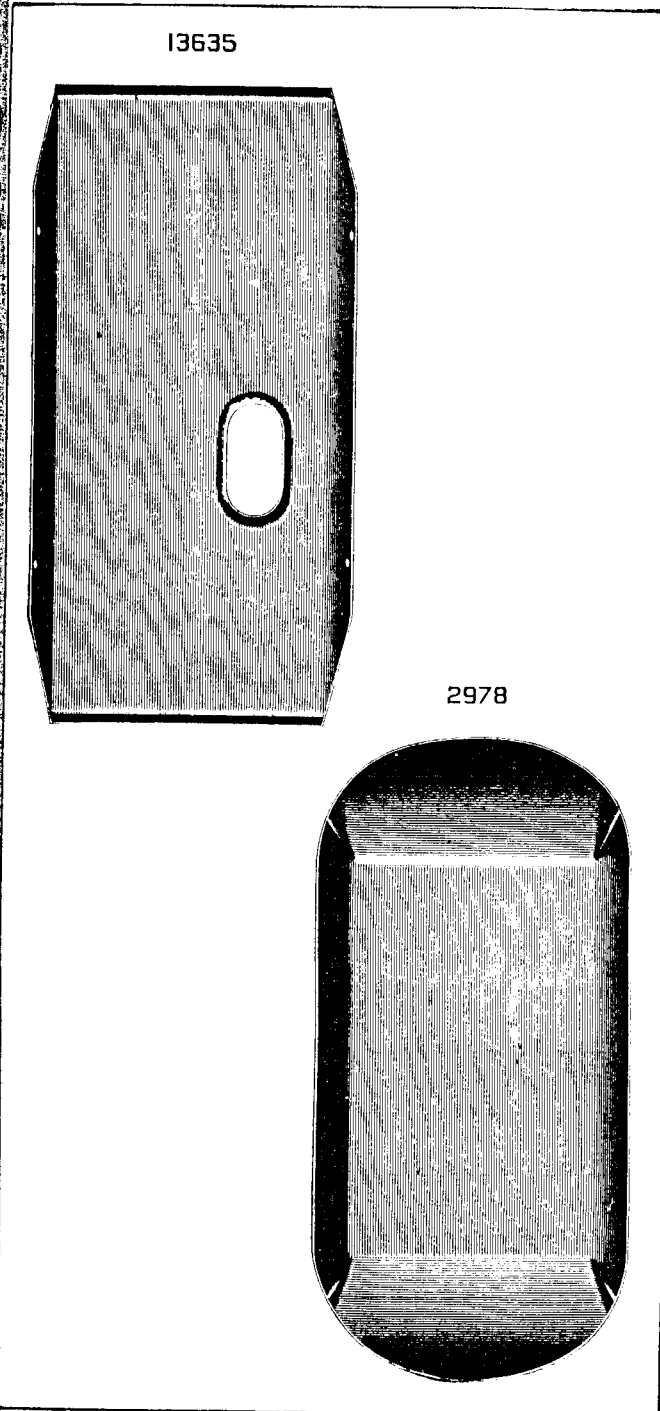

PLATE 2641—FULL SIZE

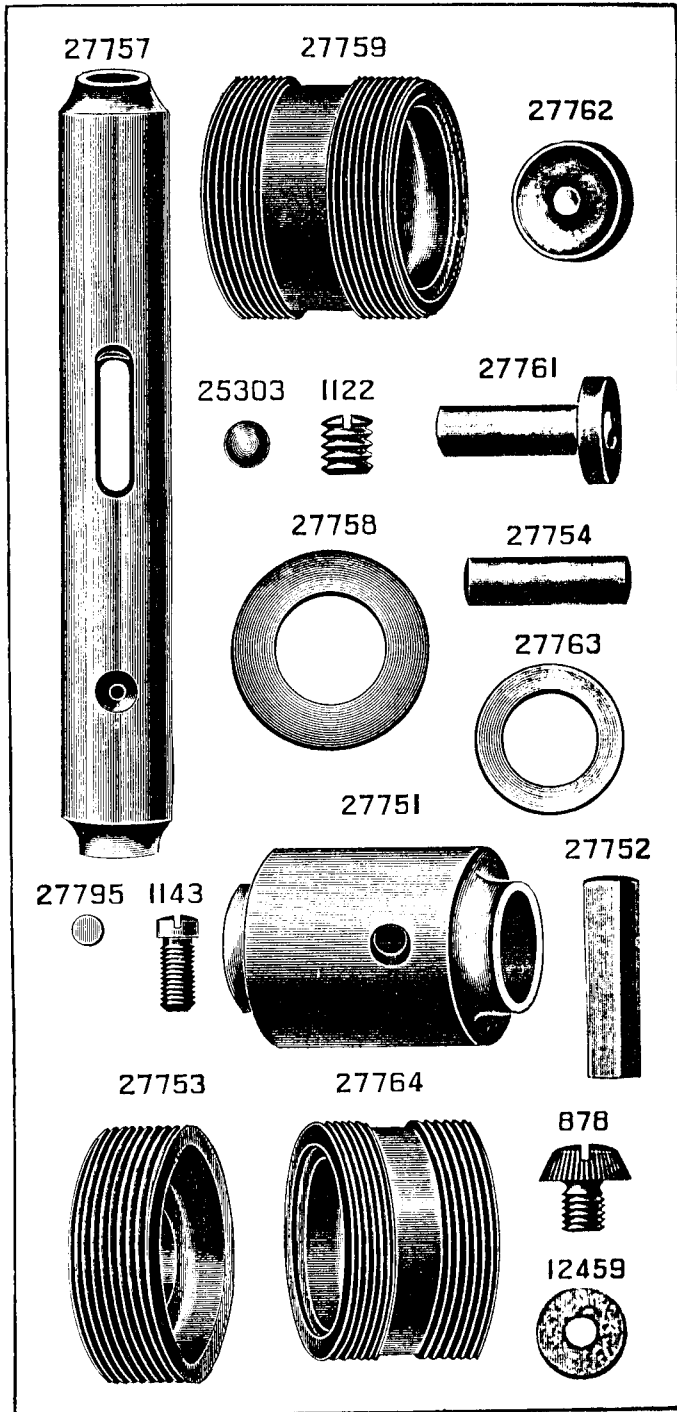

PLATE 2642—FULL SIZE

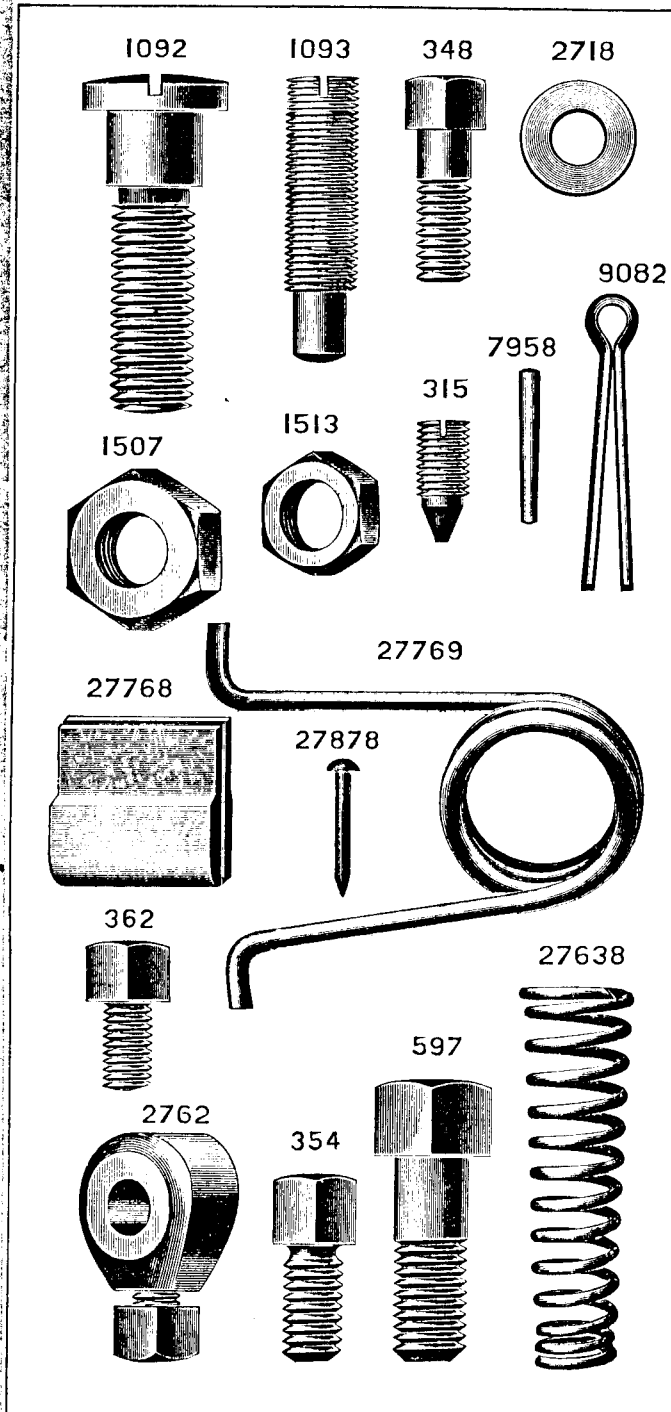

PLATE 2829—ONE-FOURTH SIZE

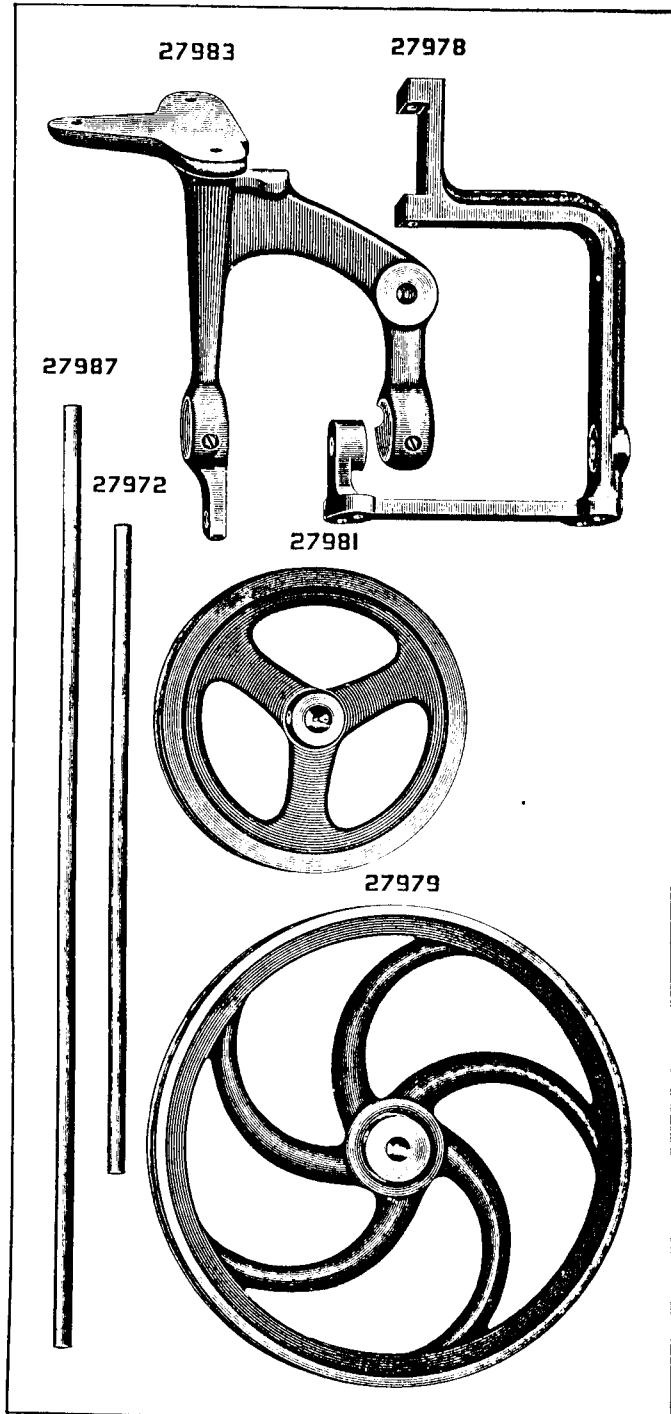

PLATE 2830—ONE-HALF SIZE

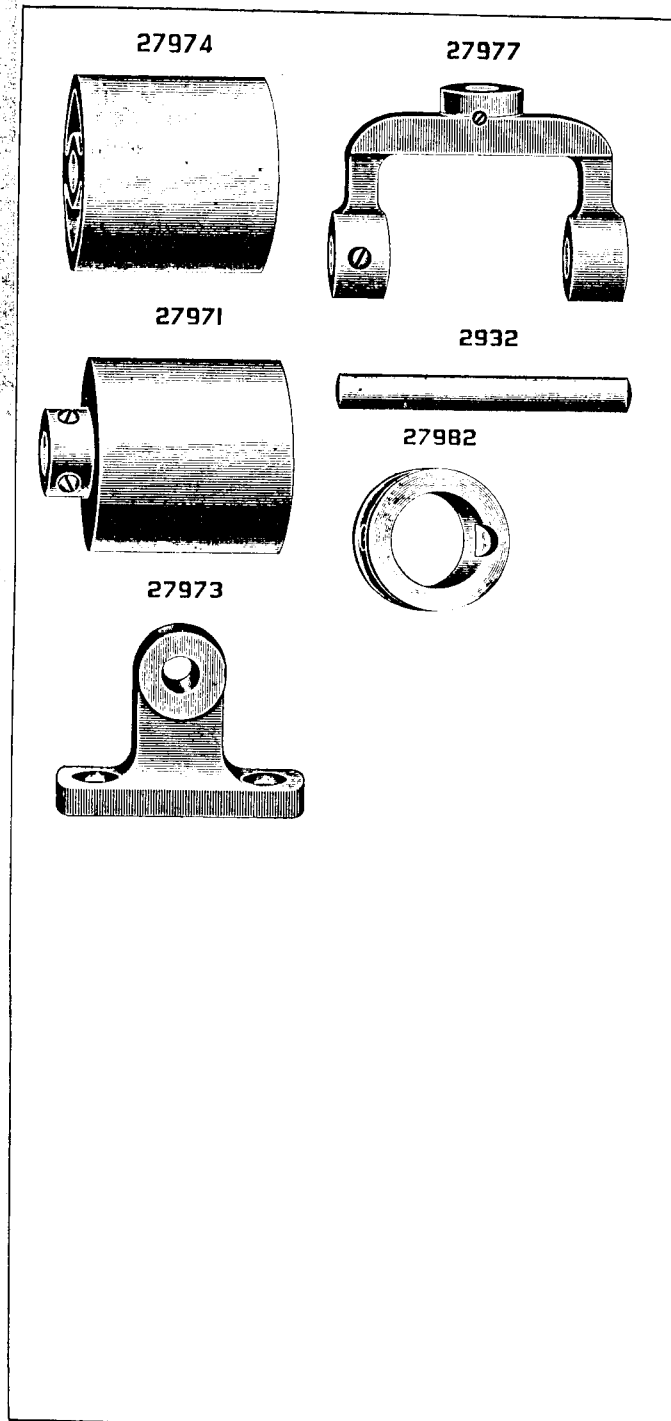



PLATE 2831—FULL SIZE

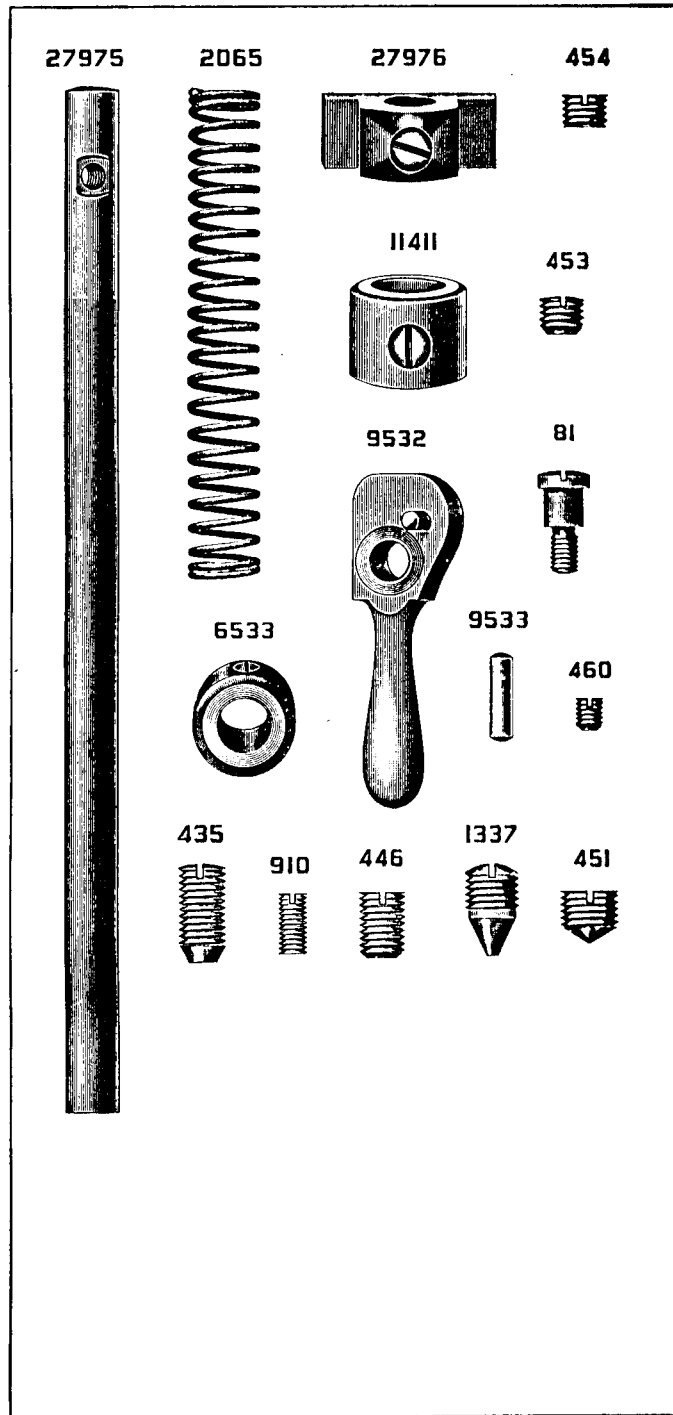
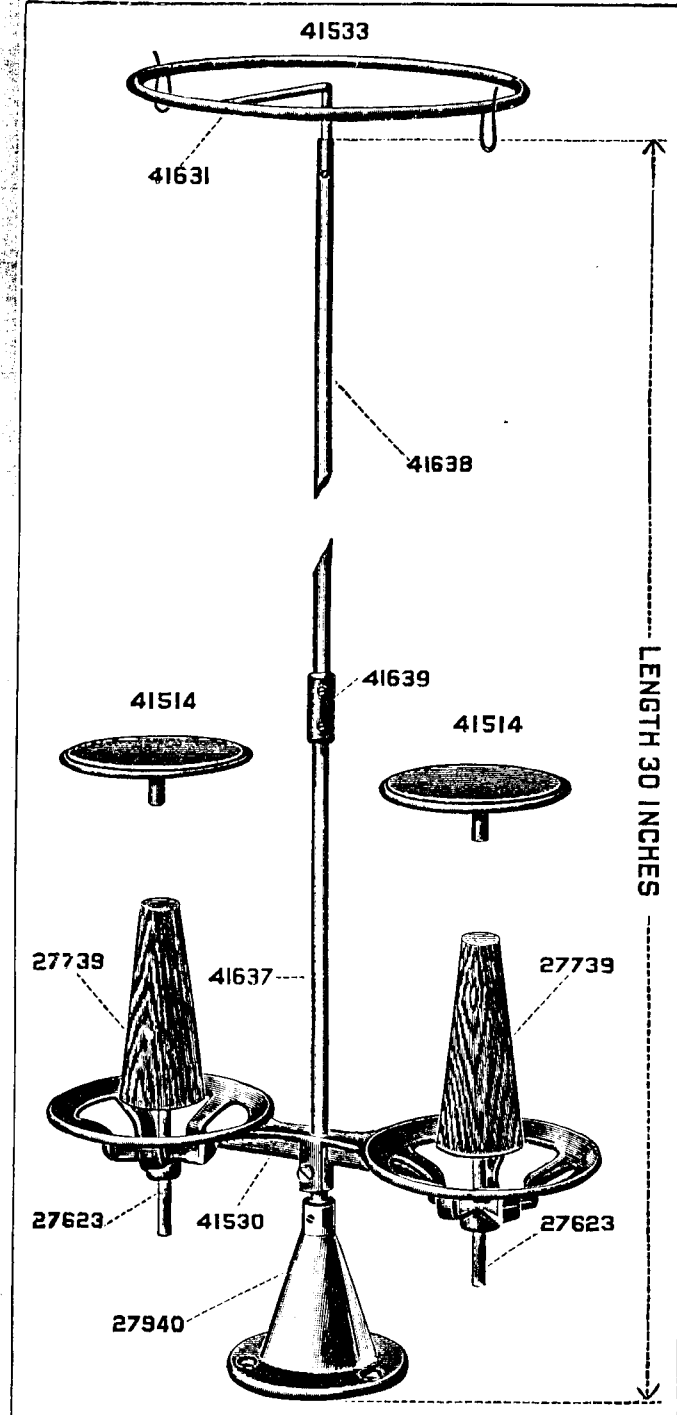

PLATE 2837—ONE-FOURTH SIZE



From the library of: Diamond Needle Corp

PLATE 3034—FULL SIZE

30355

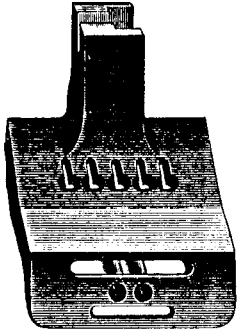

30354

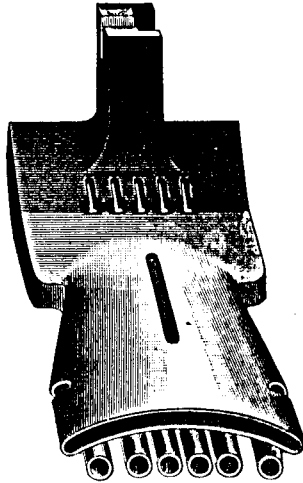

30355

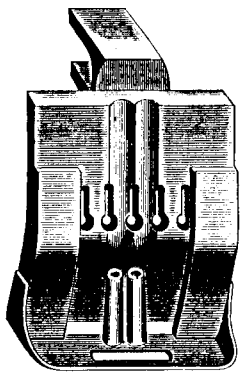

30354

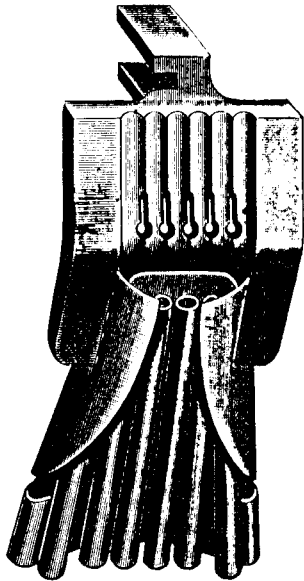
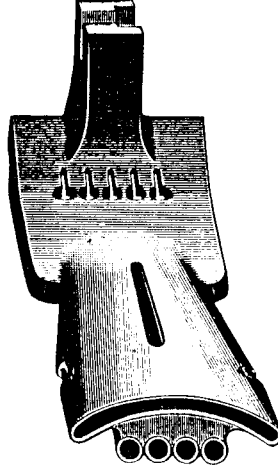
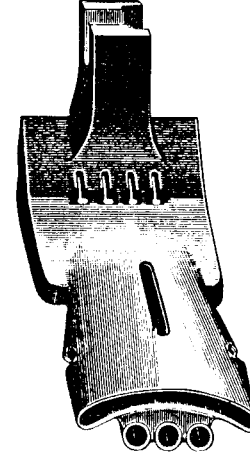

PLATE 3035—FULL SIZE

31131



31132



31131

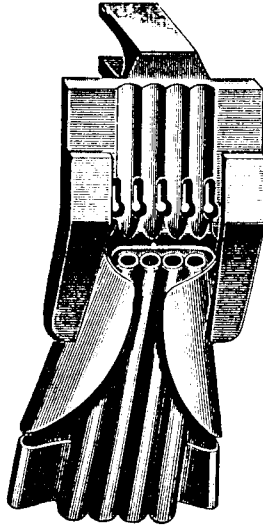

31132

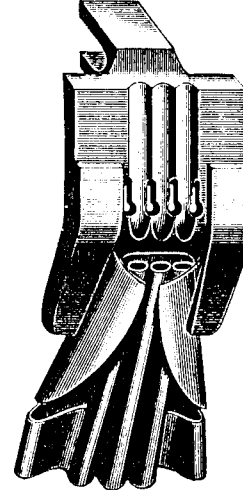

PLATE 3036—FULL SIZE

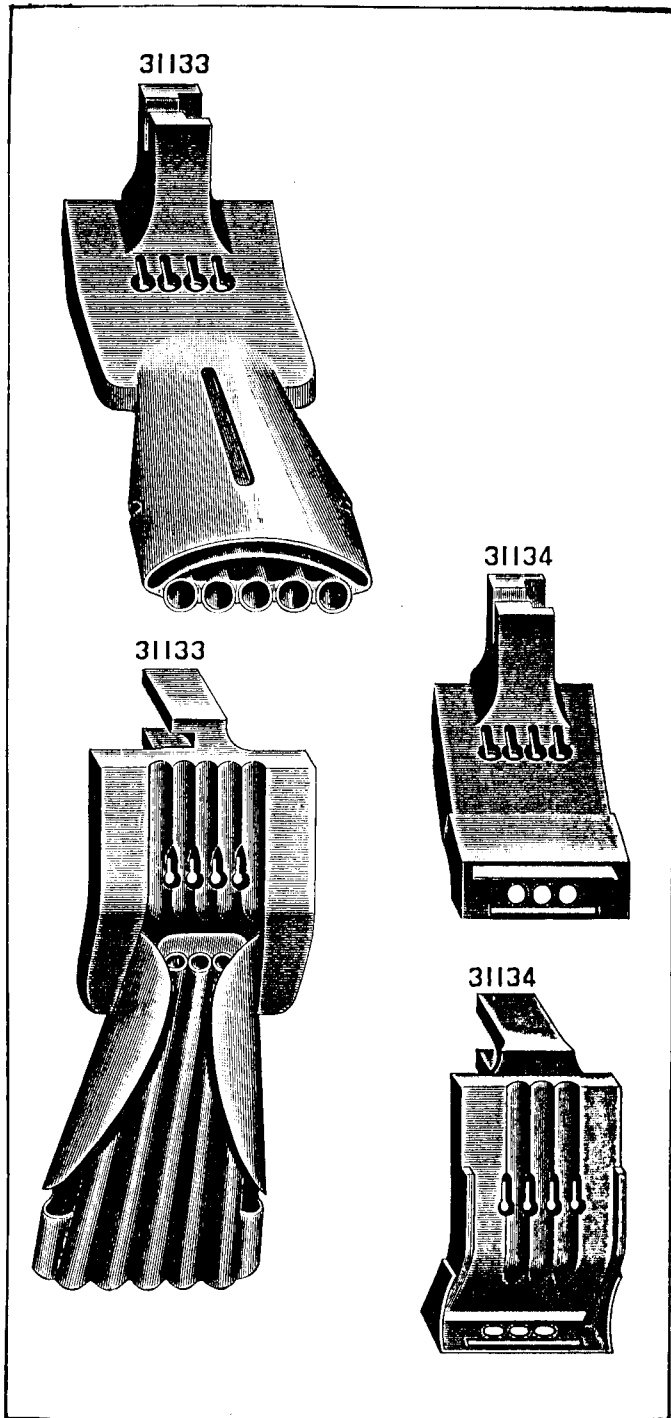

PLATE 3037—FULL SIZE

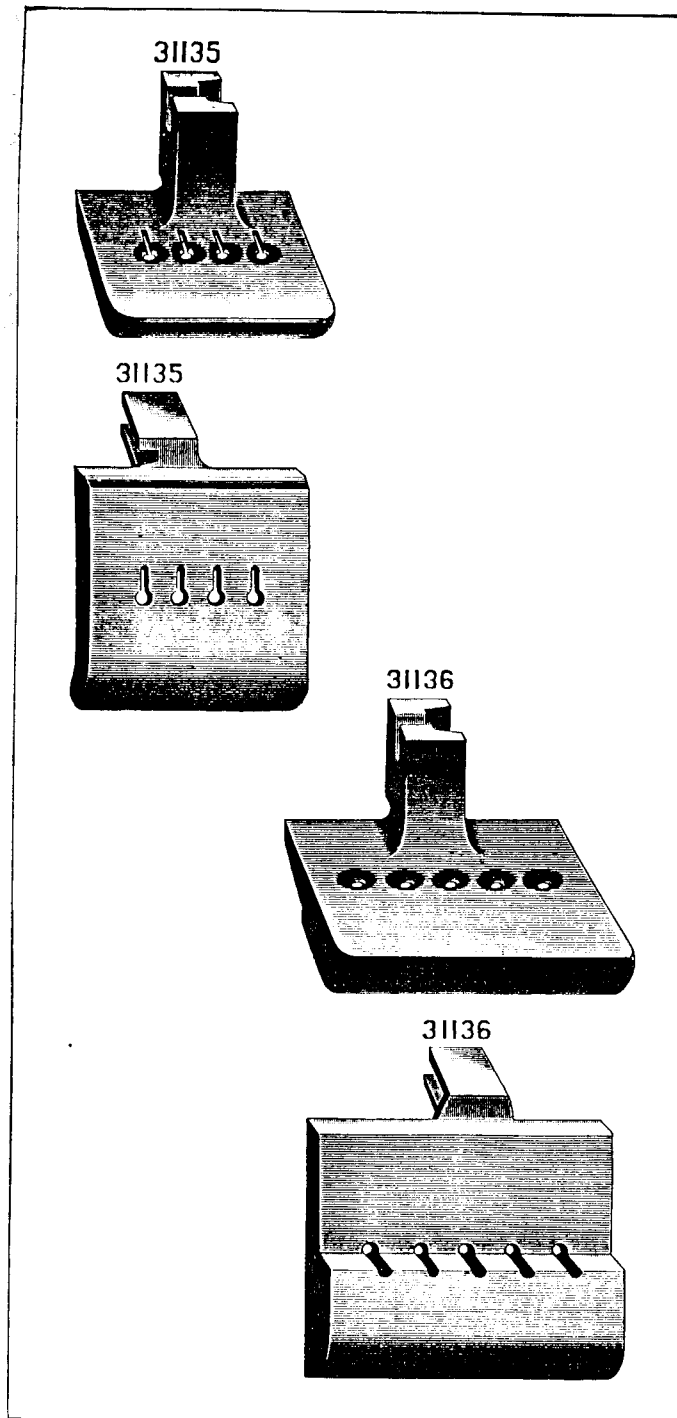

PLATE 3038—FULL SIZE

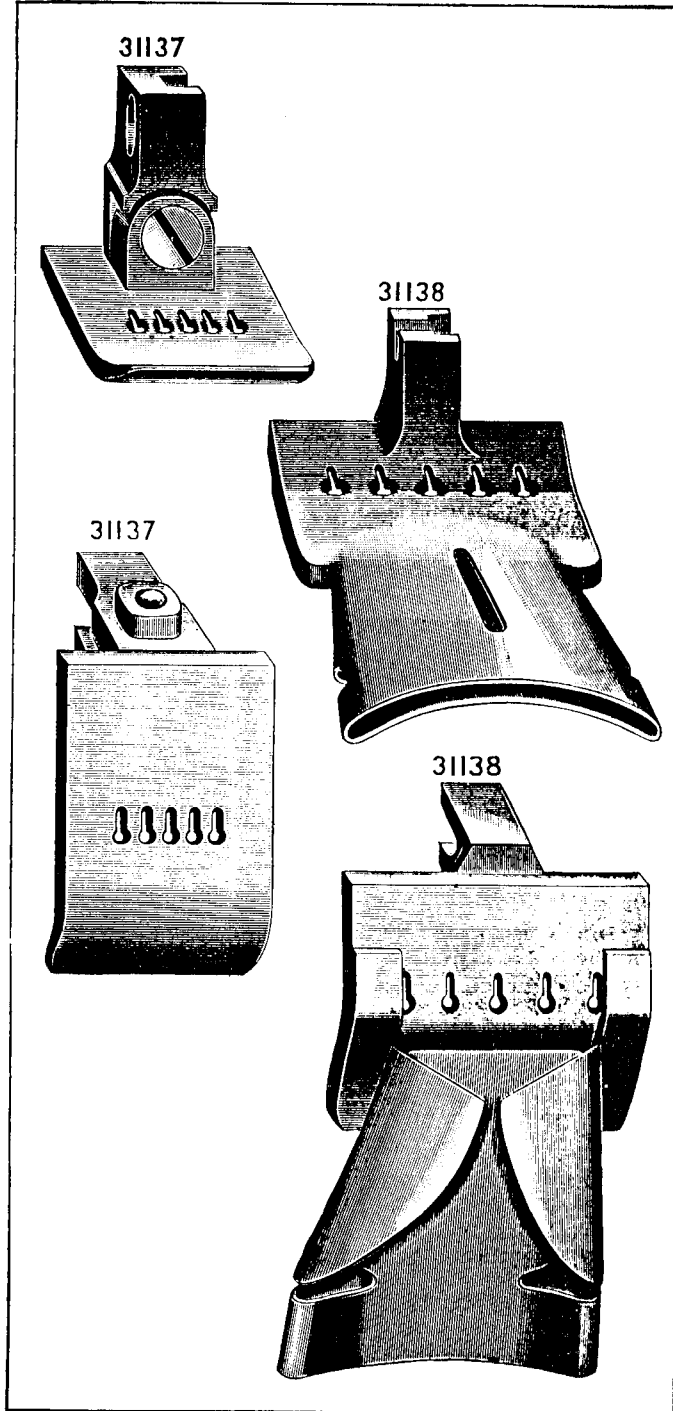

PLATE 3093—FULL SIZE

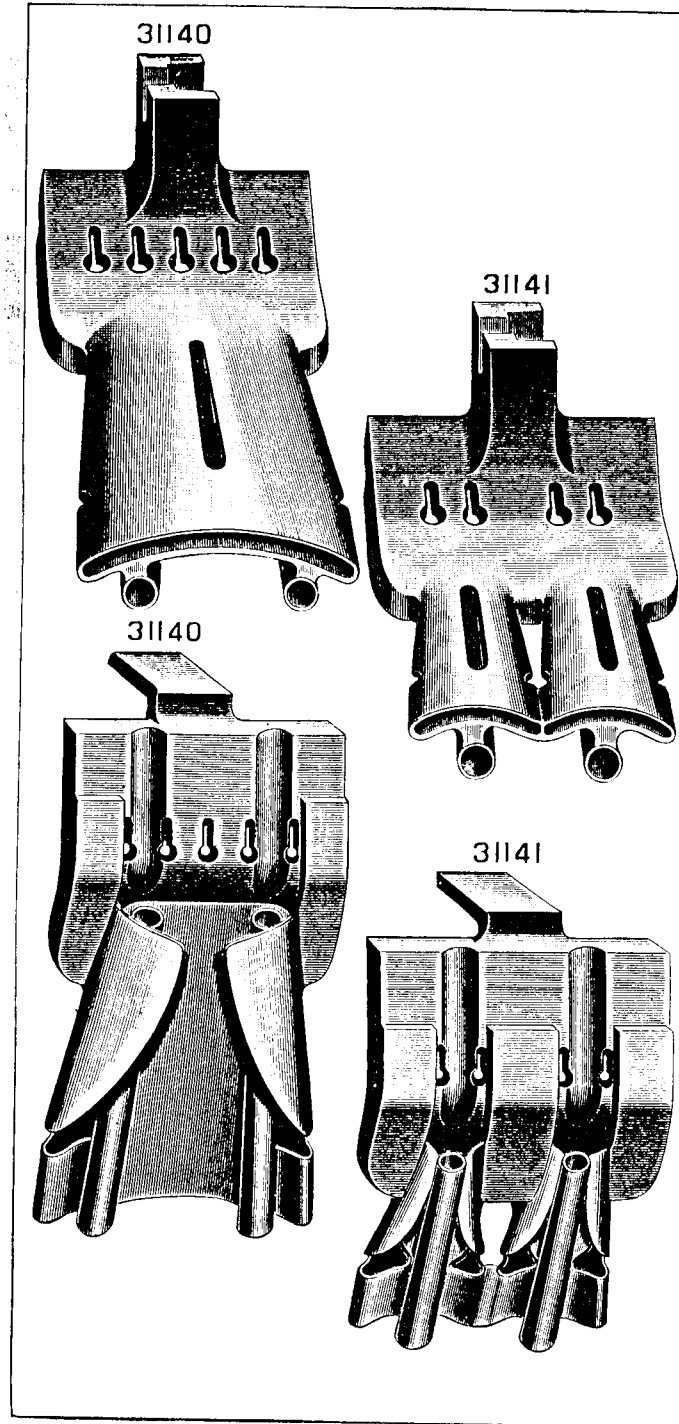

PLATE 3094—FULL SIZE

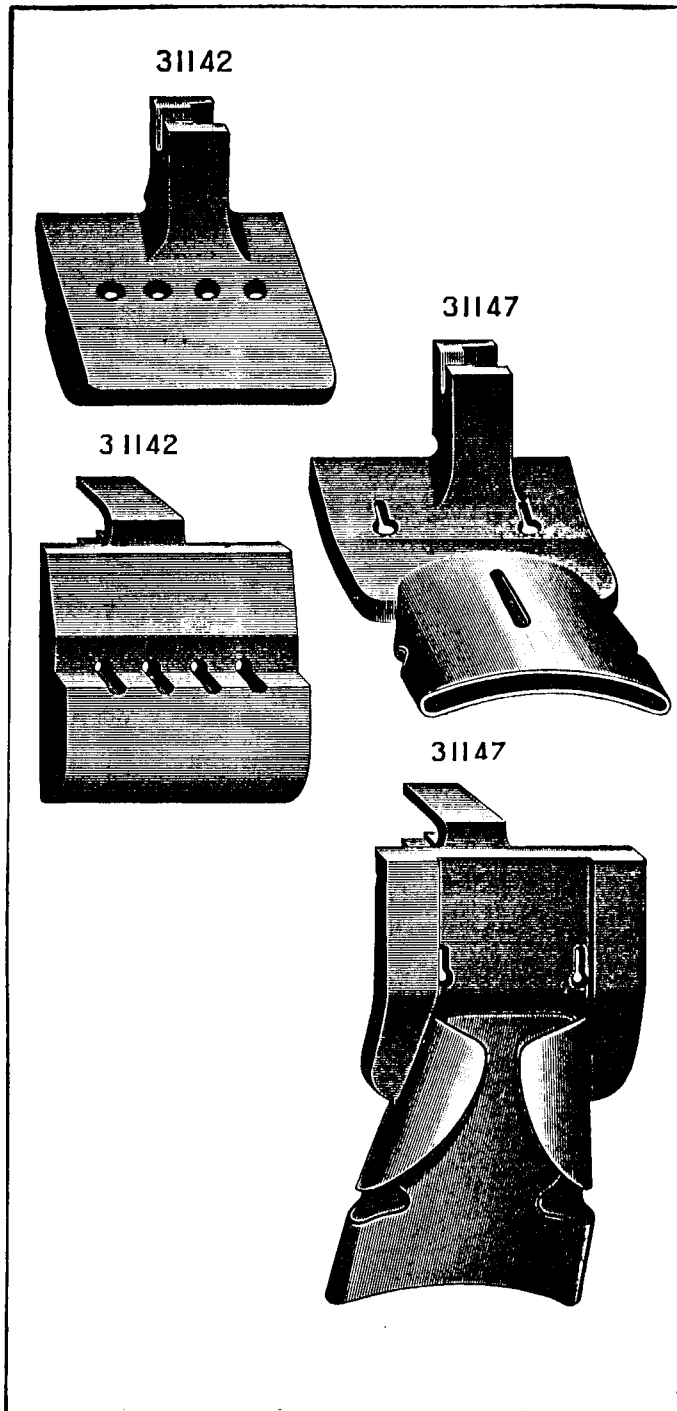

PLATE 3095—FULL SIZE

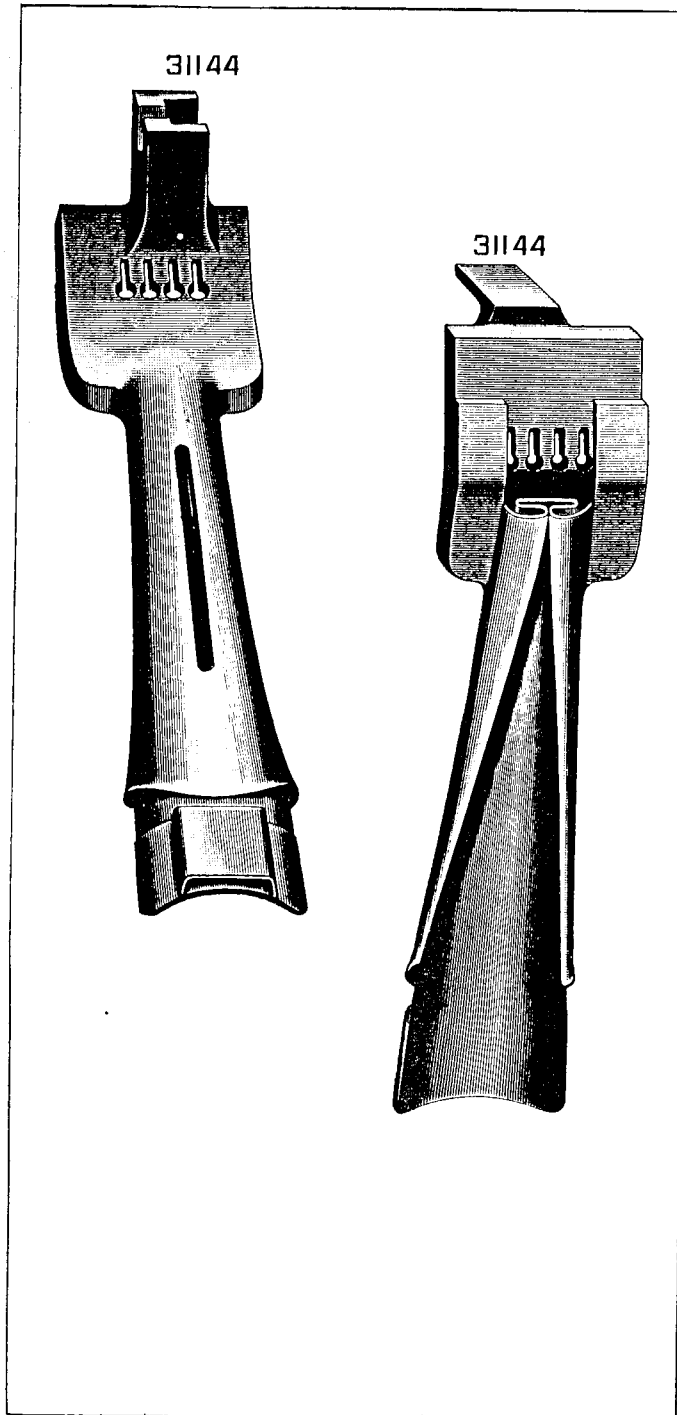
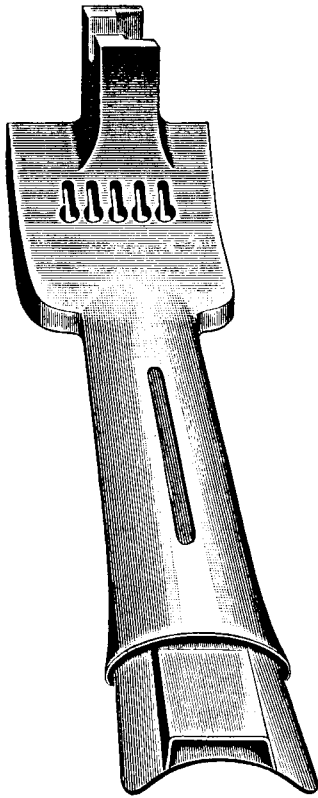

PLATE 3096—FULL SIZE

31145



31145

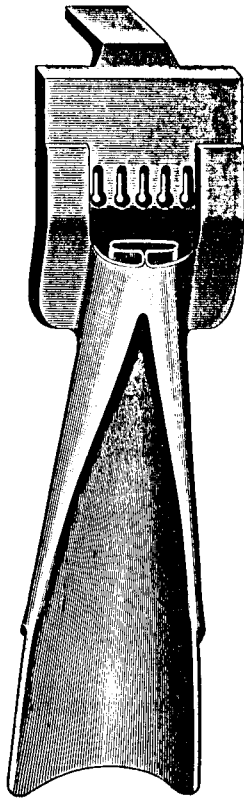
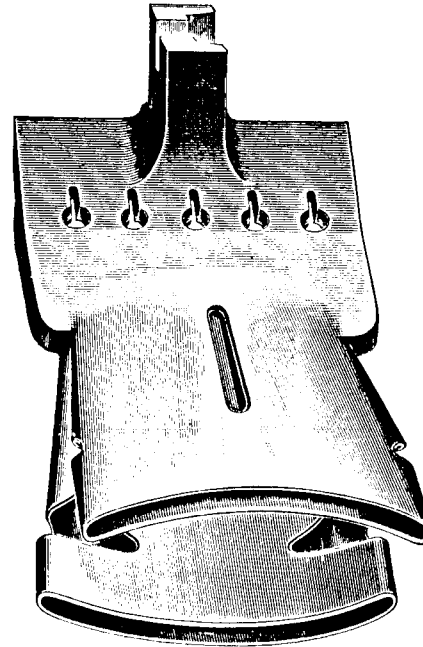

PLATE 4634—FULL SIZE

31148



31148

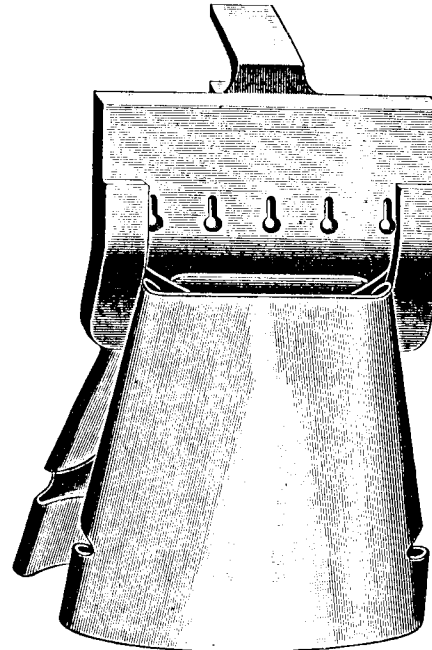
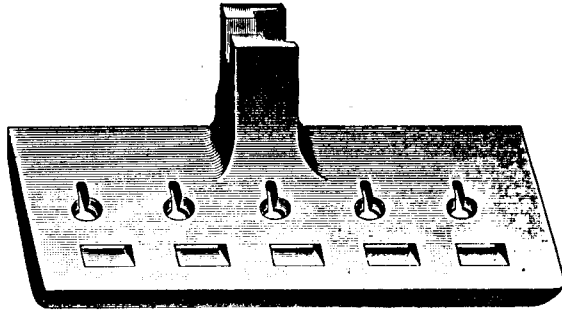

PLATE 4635—FULL SIZE

31149



31149

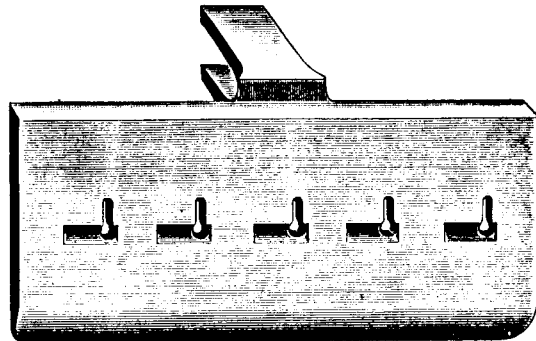
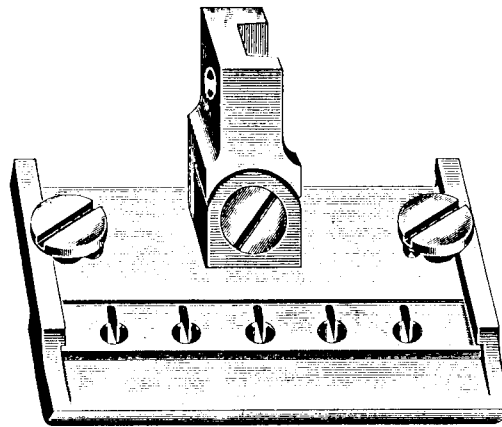

PLATE 4663—FULL SIZE

31151



31151

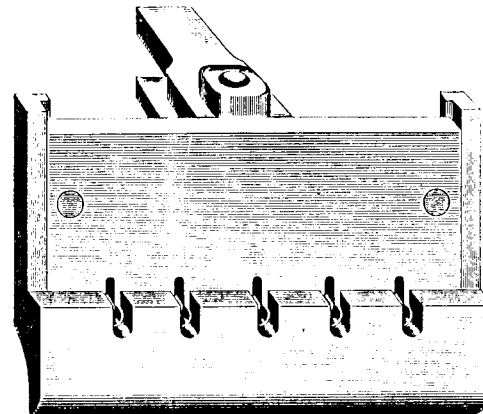
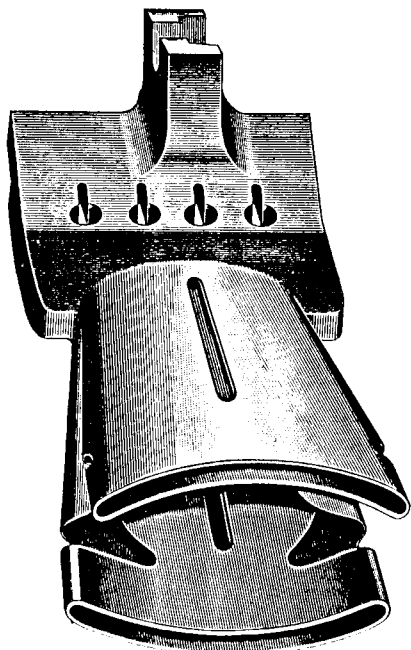

PLATE 4665—FULL SIZE

31153



31153

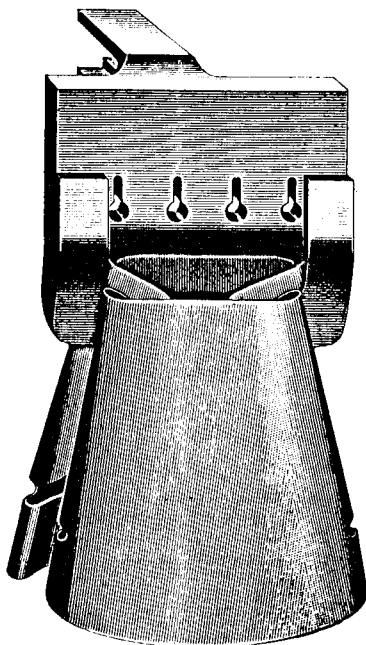
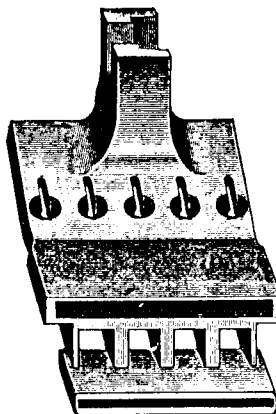
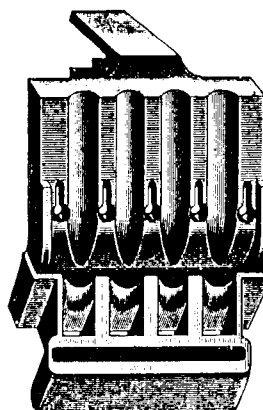

PLATE 4684—FULL SIZE

30341



30341



30342

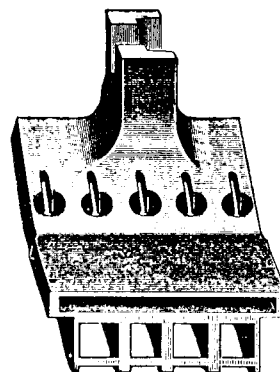

30342

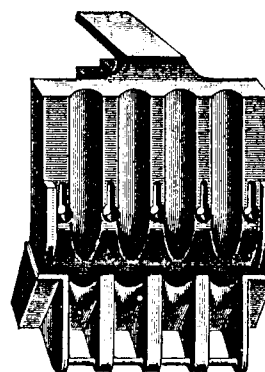
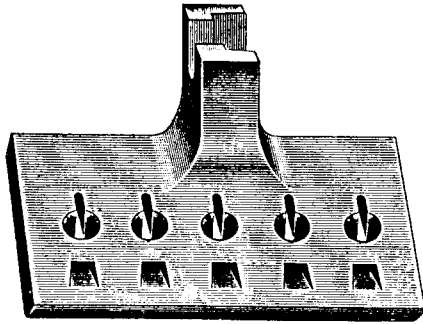

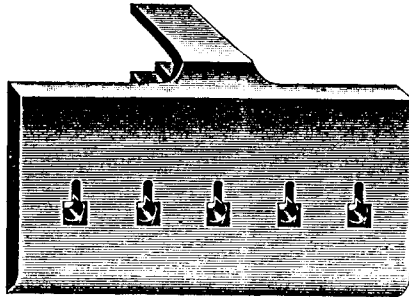

PLATE 4685—FULL SIZE

30344



30344



30348

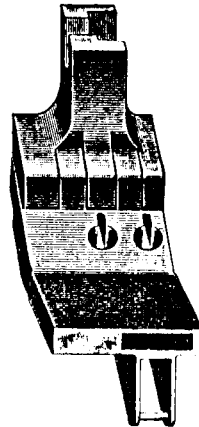

30348

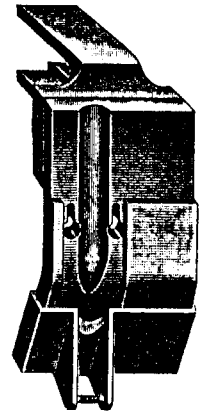
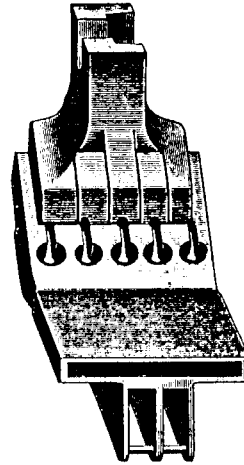
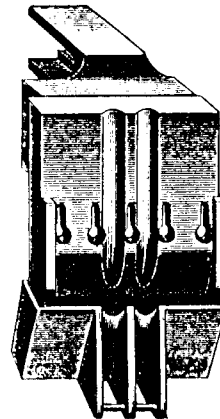

PLATE 4686—FULL SIZE

30349



30349



30350

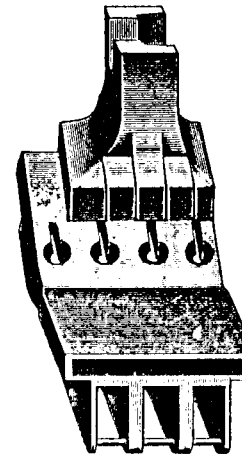

30350

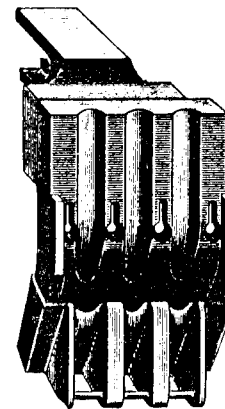
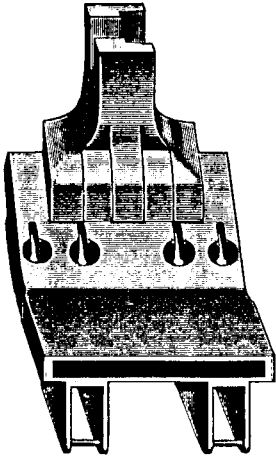
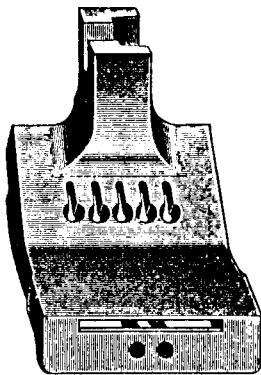

PLATE 4687—FULL SIZE

30351



30353



30351

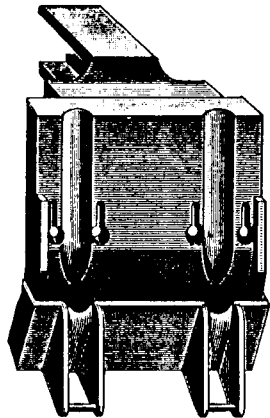

30353

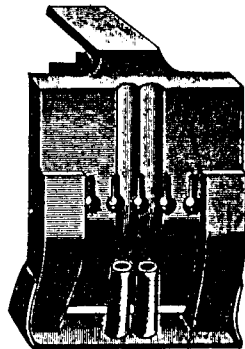
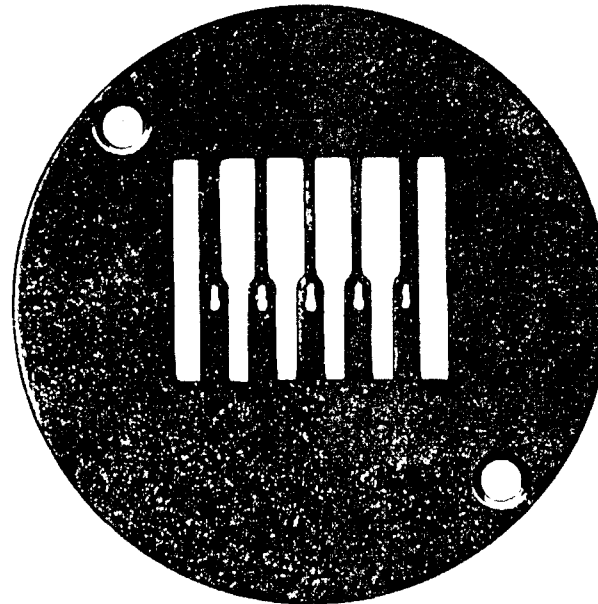

PLATE 5400—FULL SIZE

48022



48002

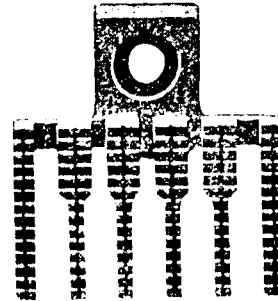
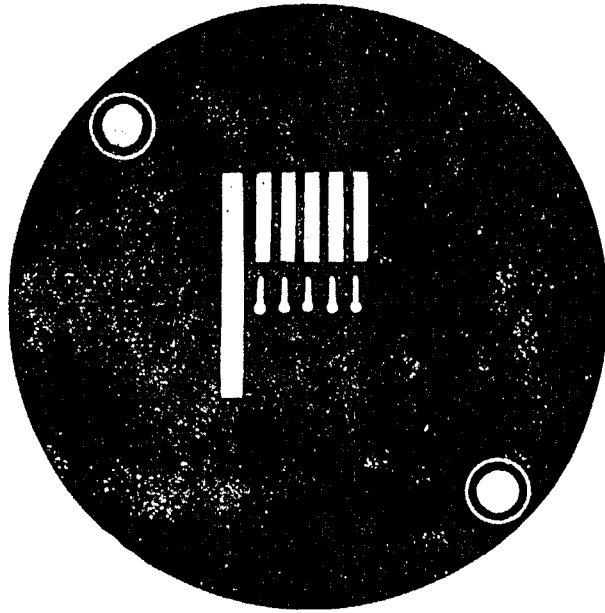

PLATE 5401—FULL SIZE

48023



48003

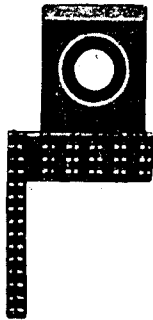
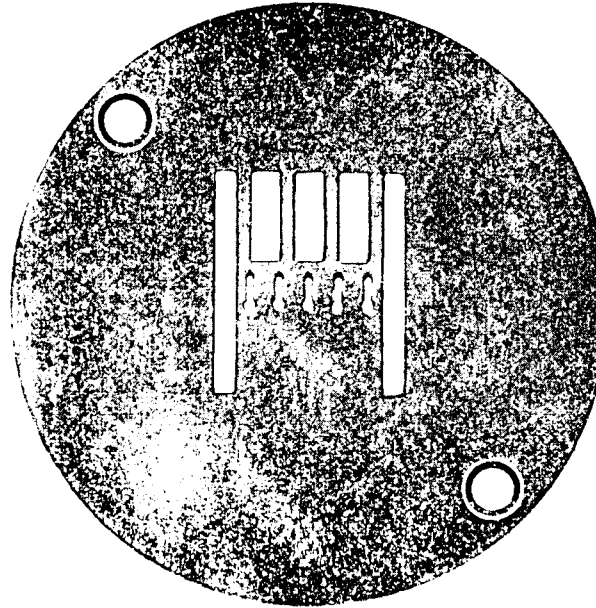

PLATE 5402—FULL SIZE

48024



48004

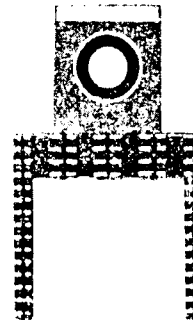

PLATE 5403—FULL SIZE

48025

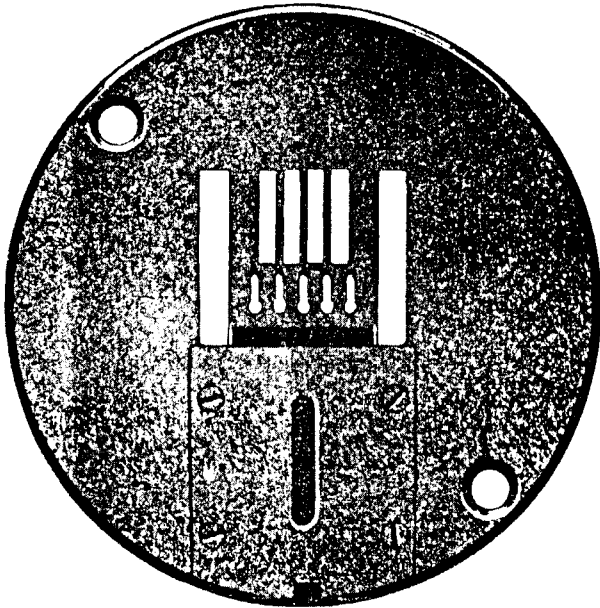
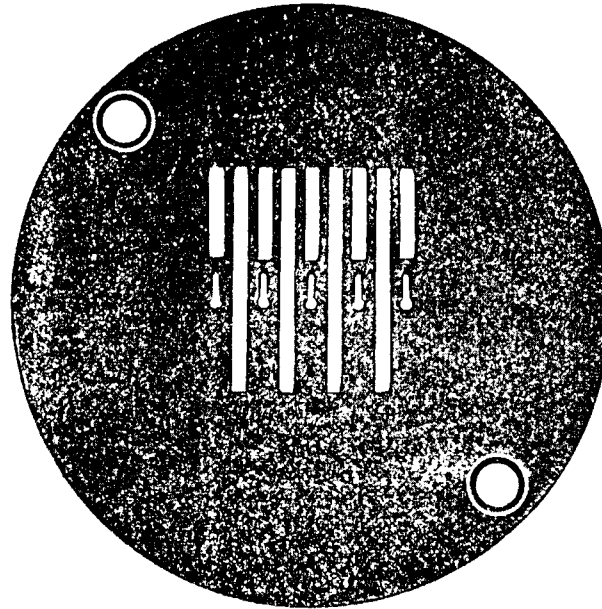
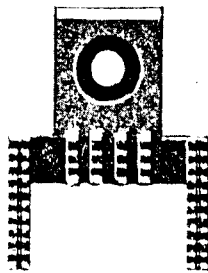

PLATE 5404—FULL SIZE

48026



48005



48006

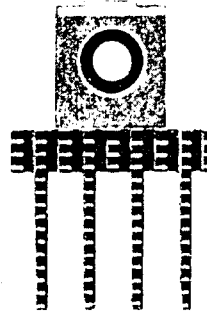

PLATE 5405—FULL SIZE

48027

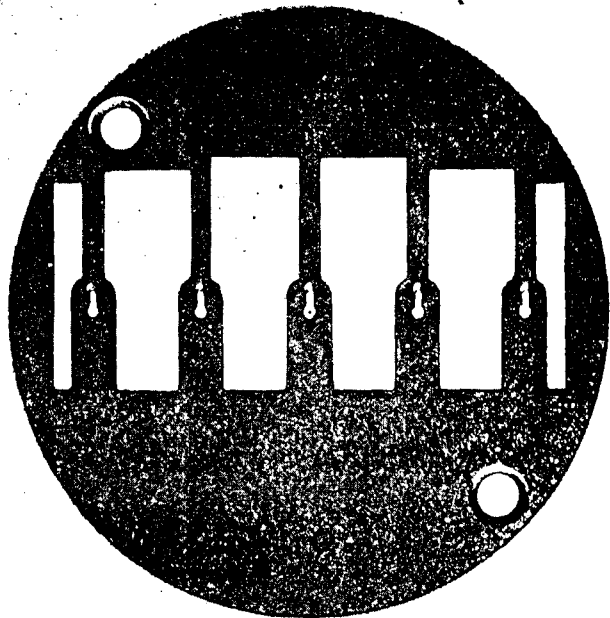
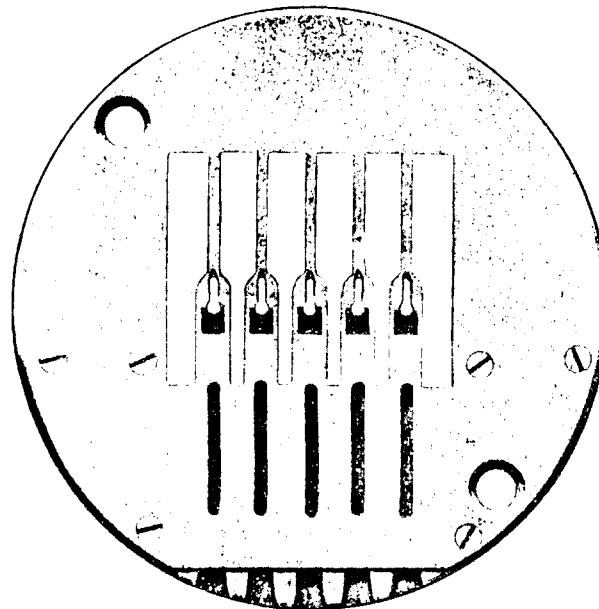
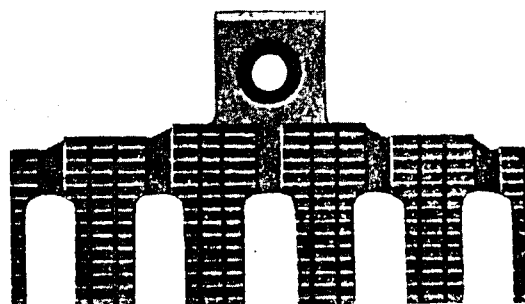

PLATE 5406—FULL SIZE

48028



48007



48008

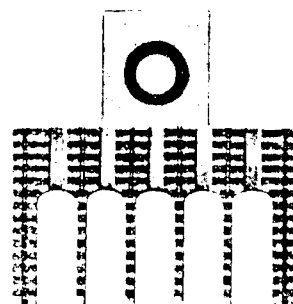
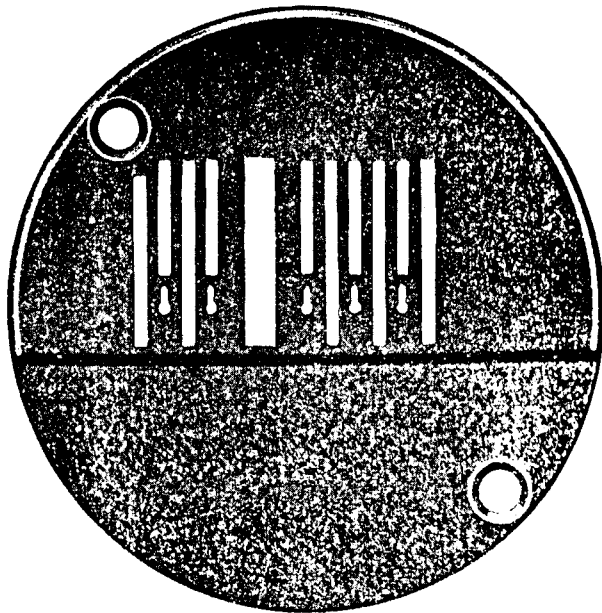

PLATE 5407—FULL SIZE

48029



48009

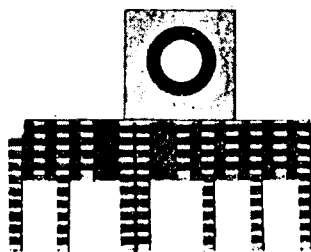
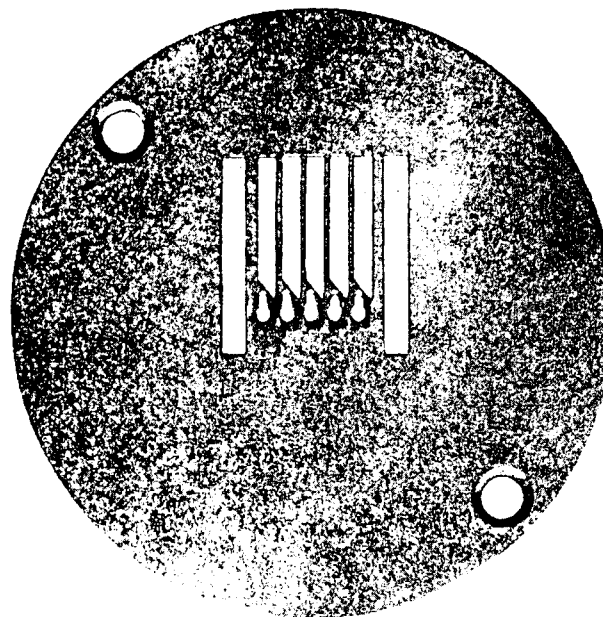
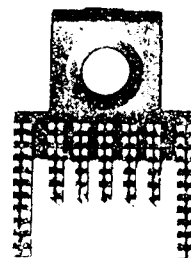

PLATE 5408—FULL SIZE

47897



47862



47864

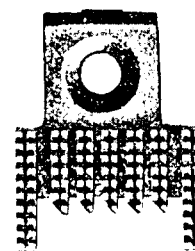
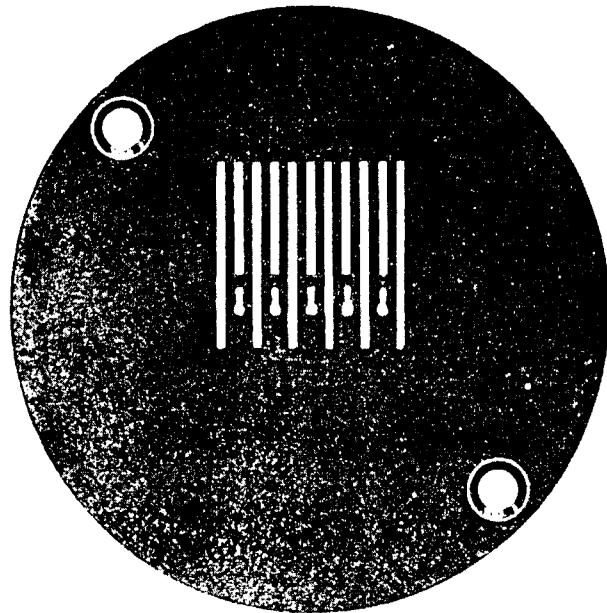

PLATE 5409—FULL SIZE

47898



47863

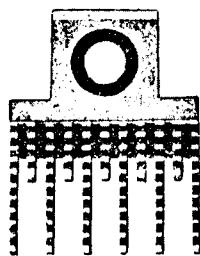
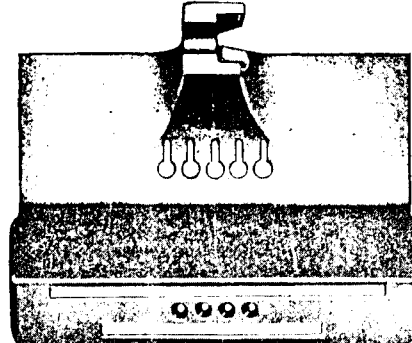

PLATE 5431—FULL SIZE

31154



31154

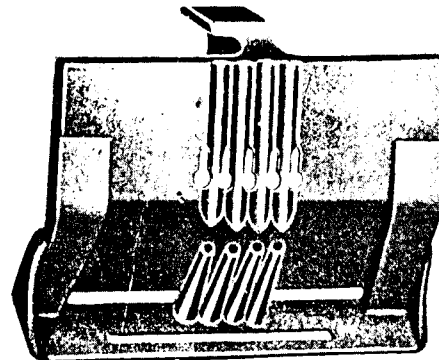
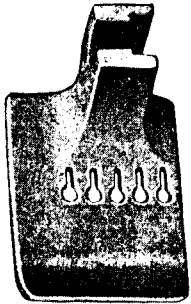
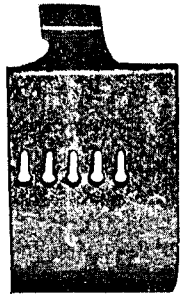

PLATE 5446 — FULL SIZE

31156



31156



31158

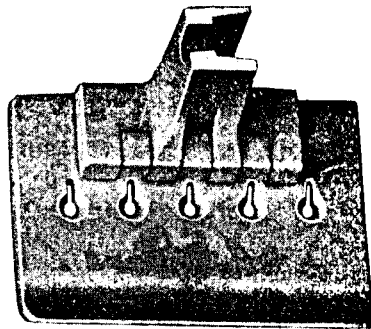

31158

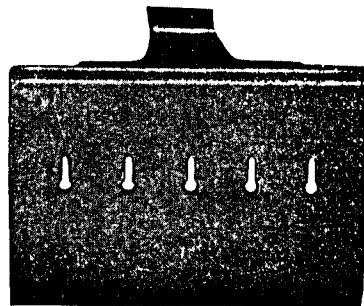
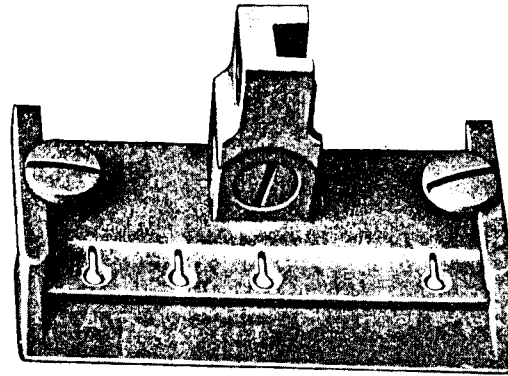

PLATE 5447 — FULL SIZE

31157



31157

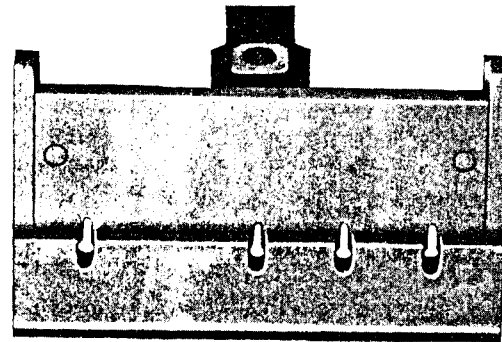



PLATE 5459—FULL SIZE

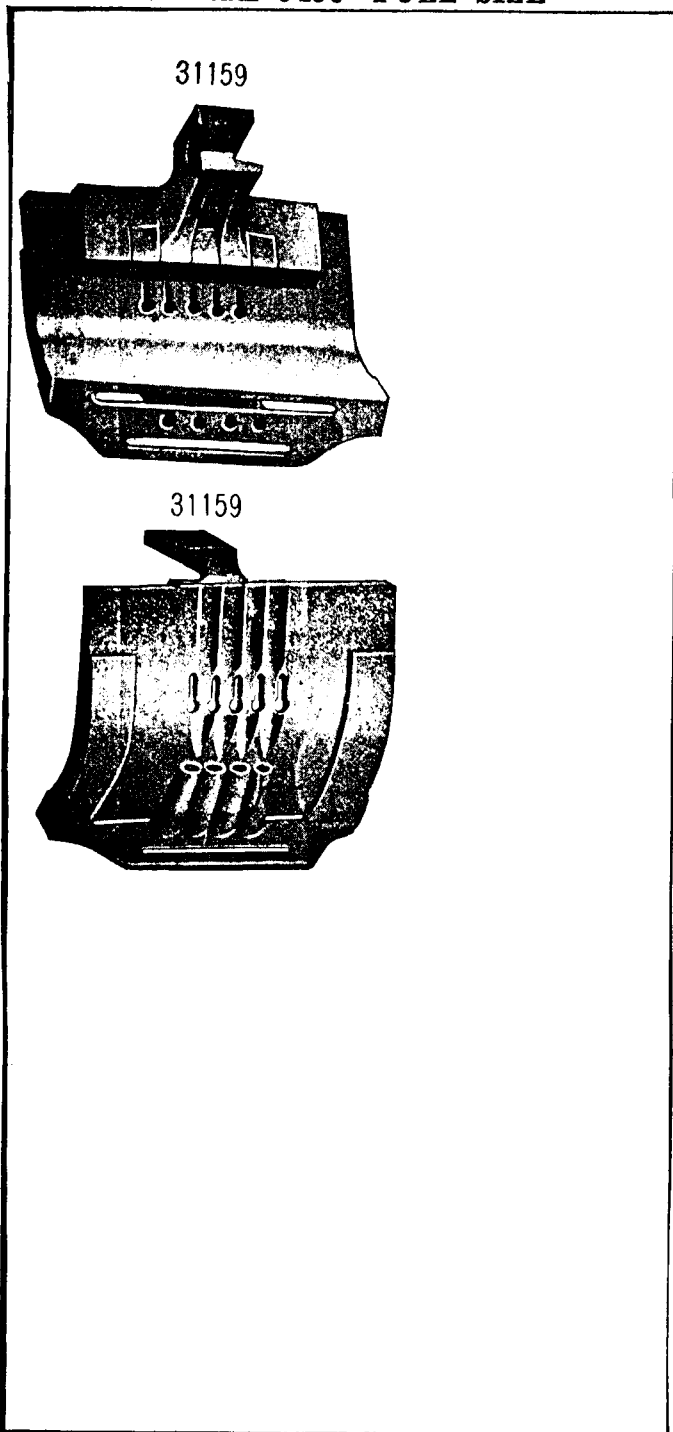

PLATE 5460—FULL SIZE

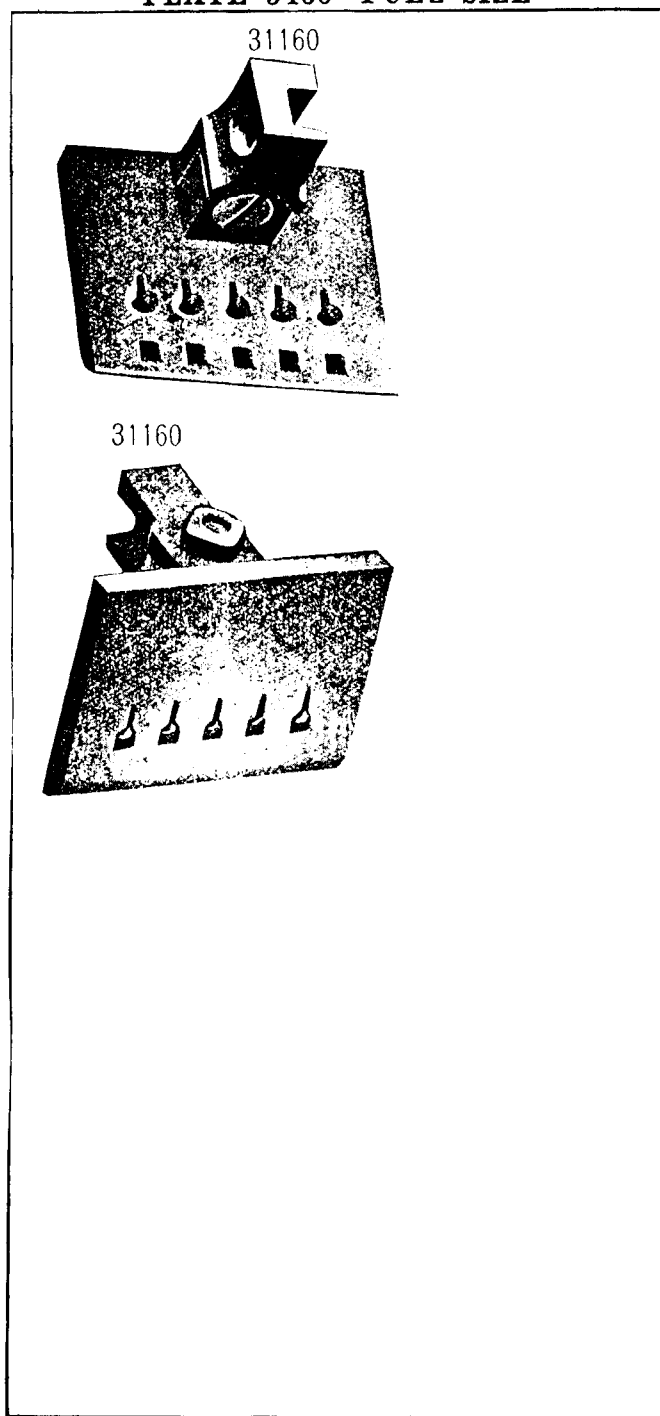

PLATE 5497—FULL SIZE

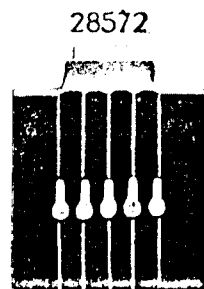
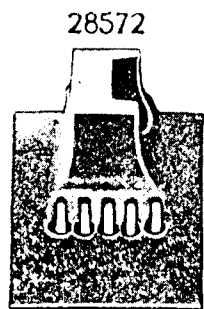
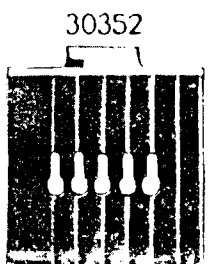
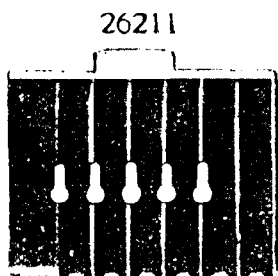
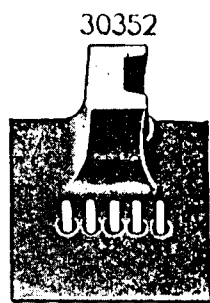
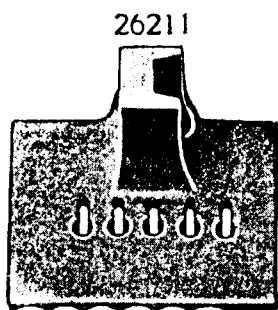

PLATE 5498—FULL SIZE

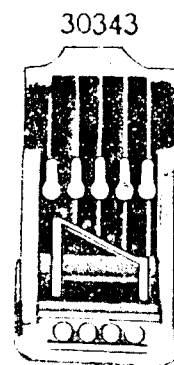
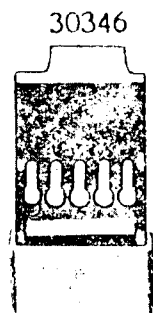

PLATE 5499—FULL SIZE

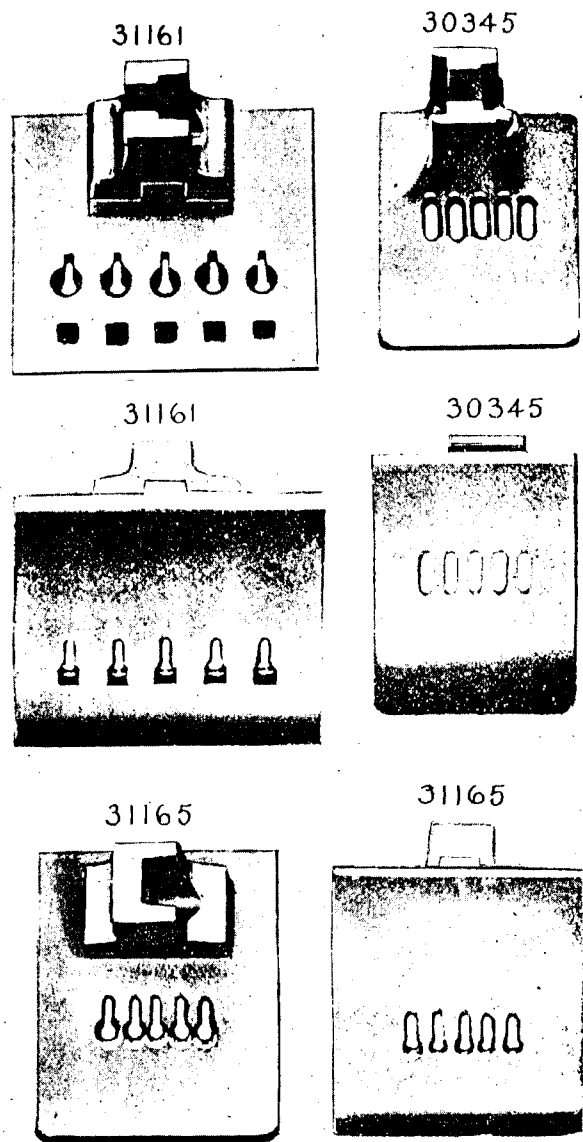
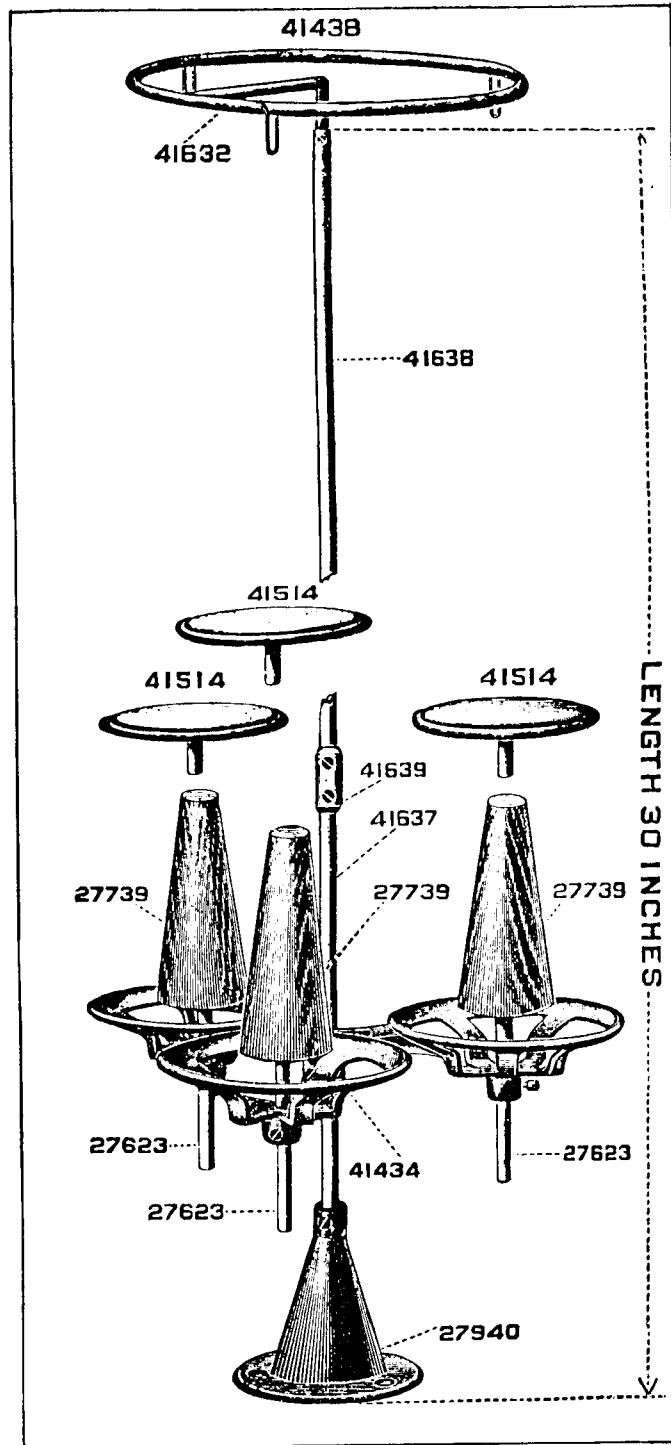

PLATE 5571—ONE-FOURTH SIZE



From the library of: Diamond Needle Corp

PLATE 7440—ONE-HALF SIZE

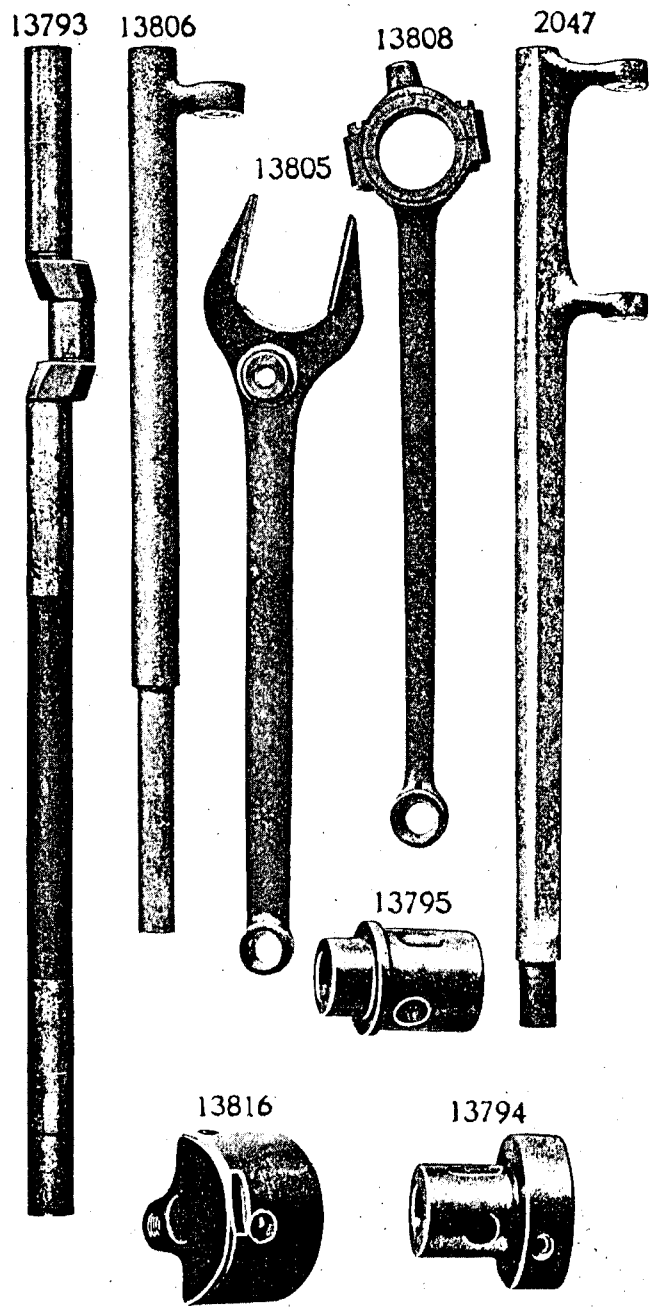
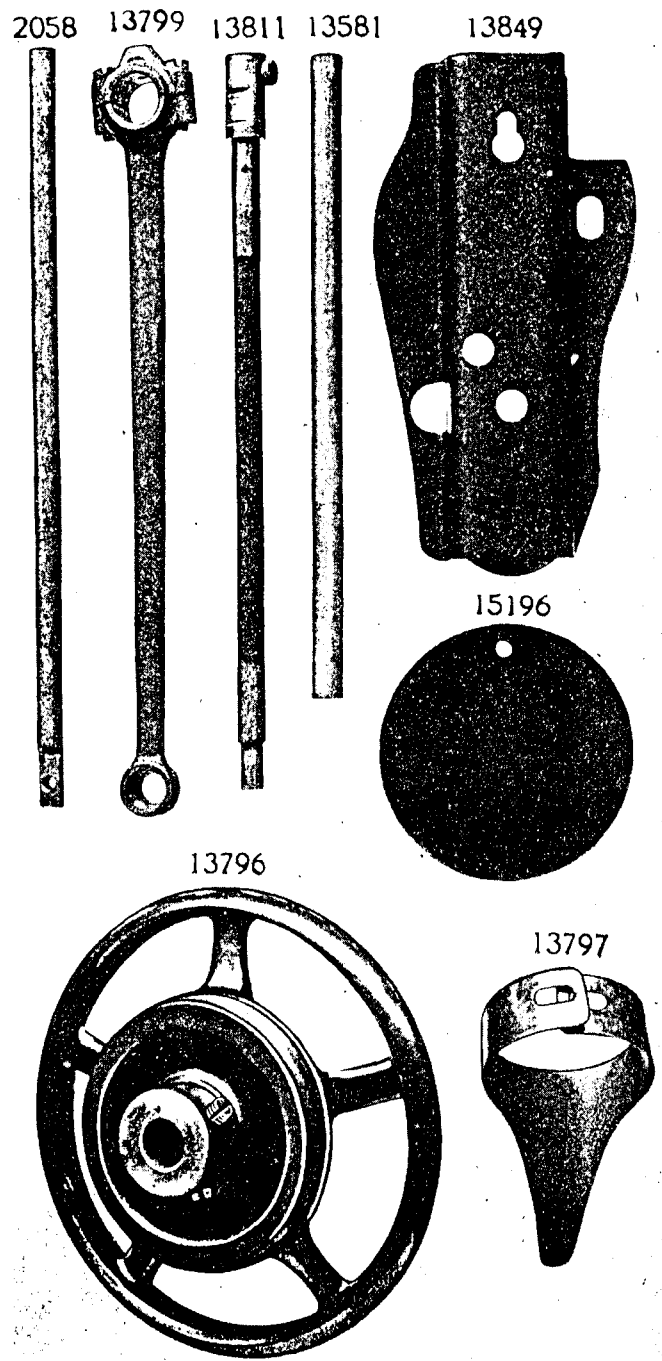

PLATE 7441—ONE-HALF SIZE



From the library of: Diamond Needle Corp

PLATE 7442—FULL SIZE

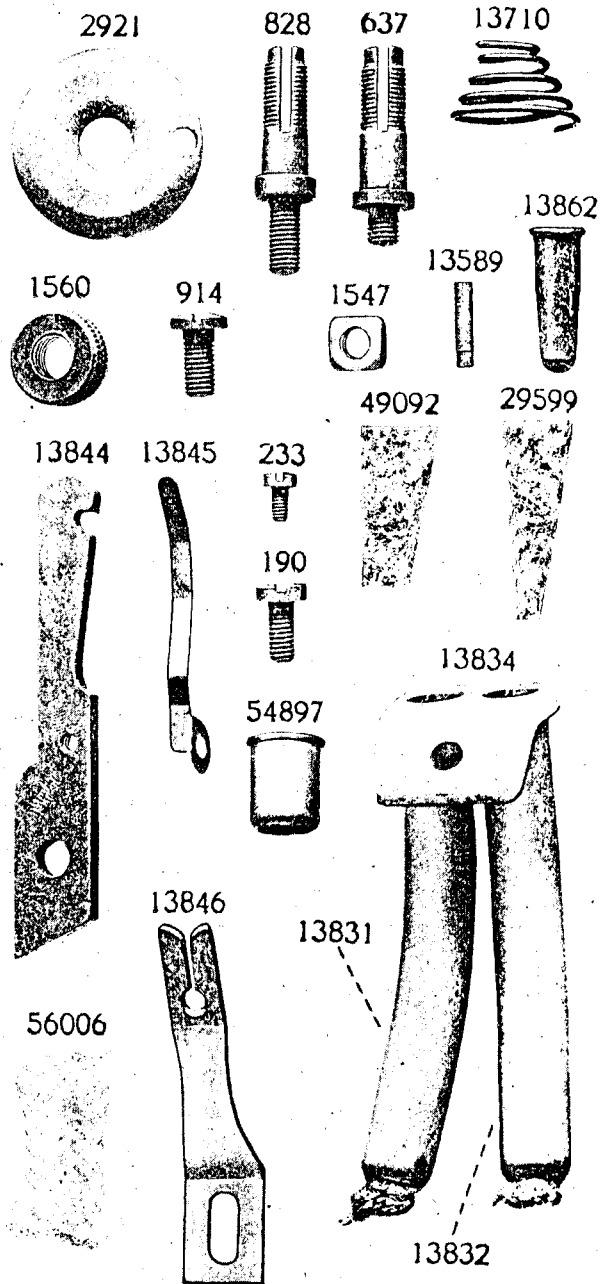

PLATE 7443—FULL SIZE

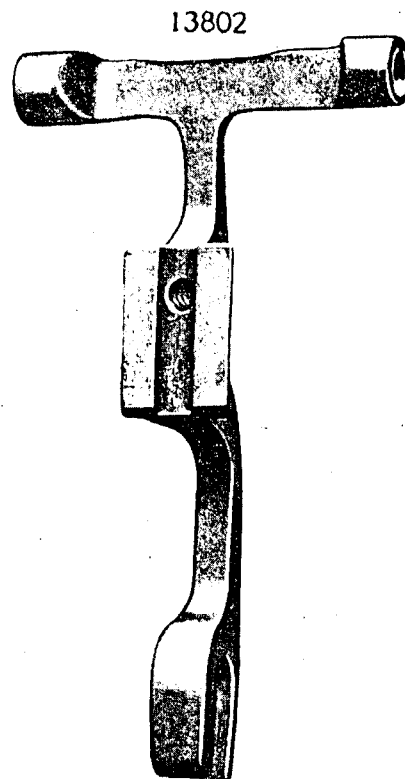

PLATE 7444—FULL SIZE

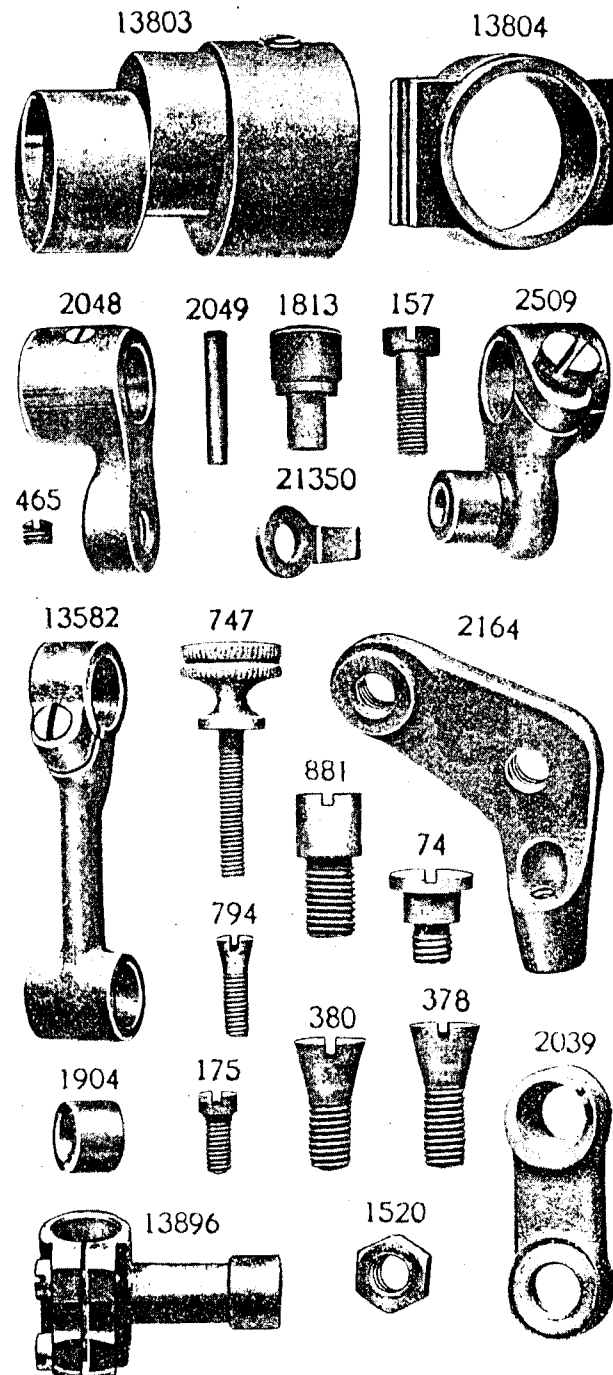

PLATE 7445—FULL SIZE

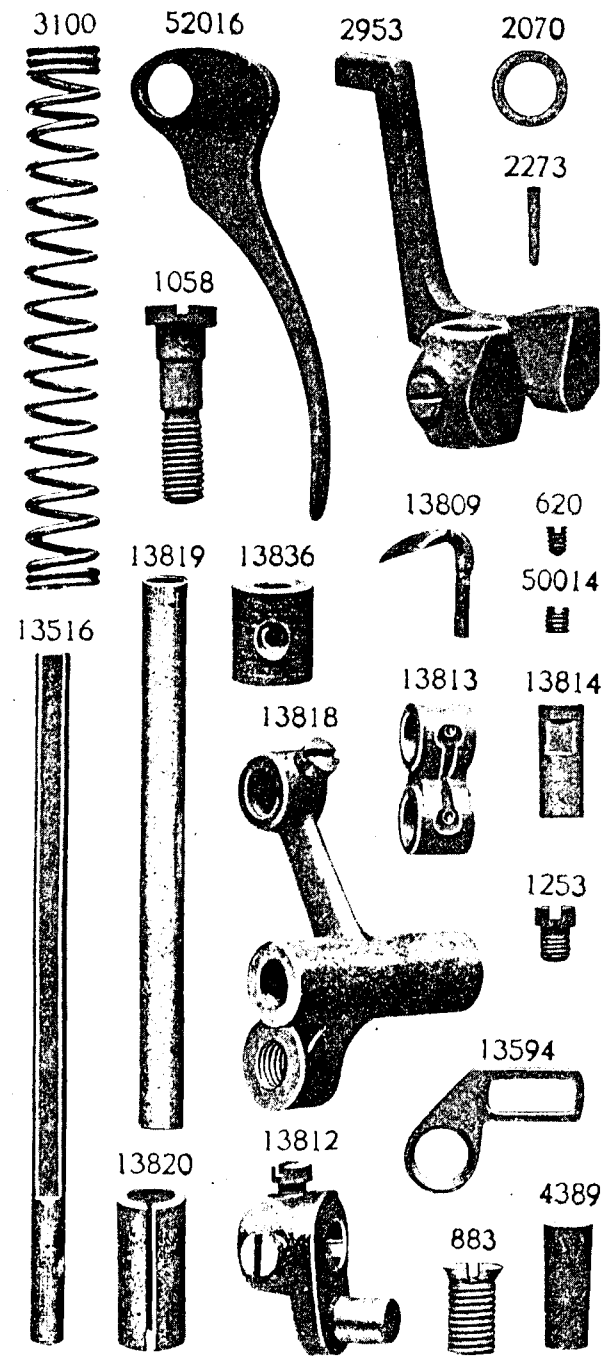

PLATE 7446—FULL SIZE

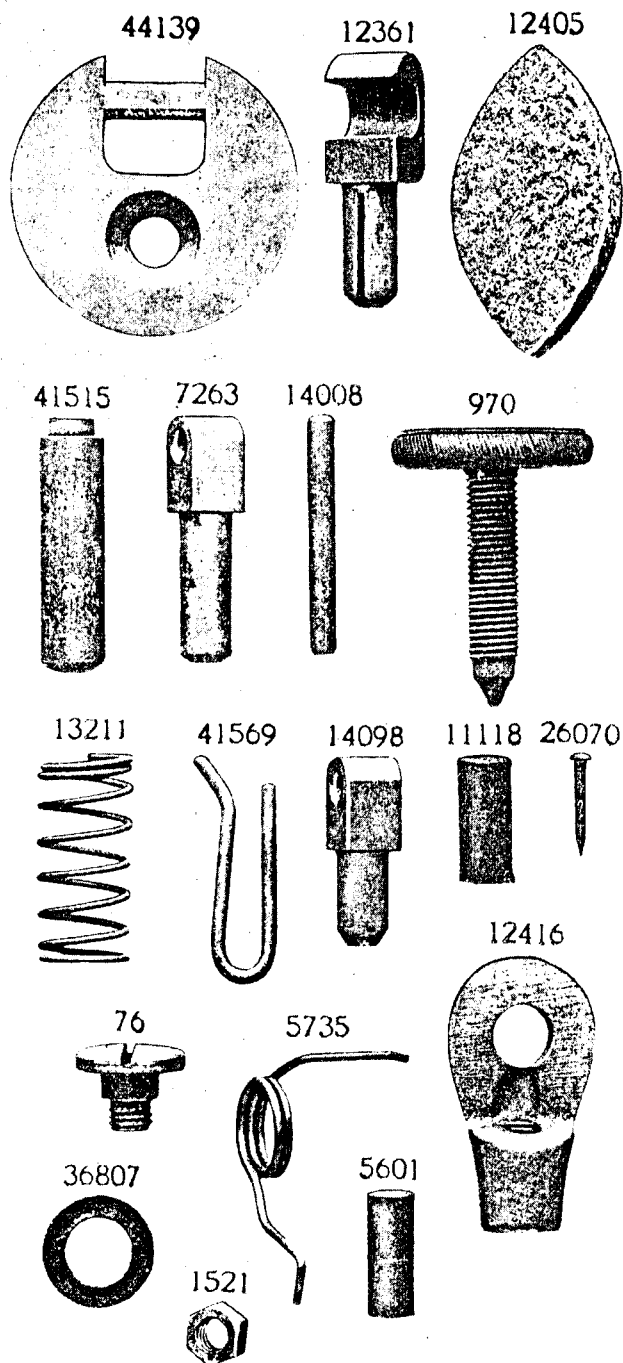

PLATE 7447—ONE-HALF SIZE

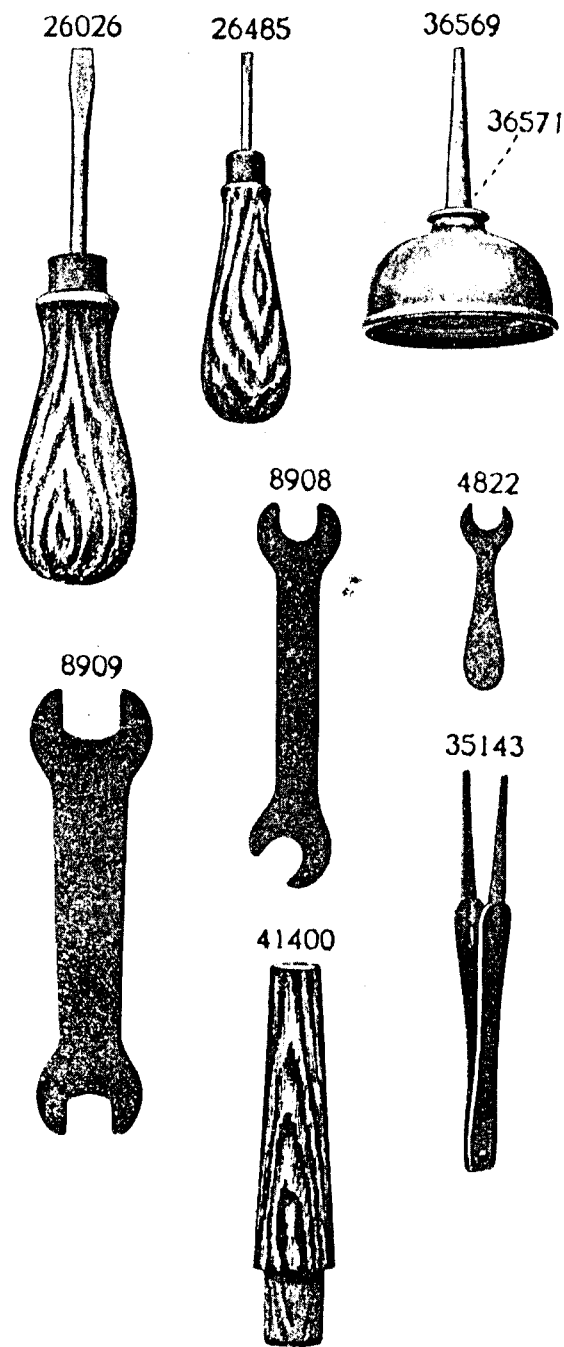

PLATE 7448—ONE-HALF SIZE

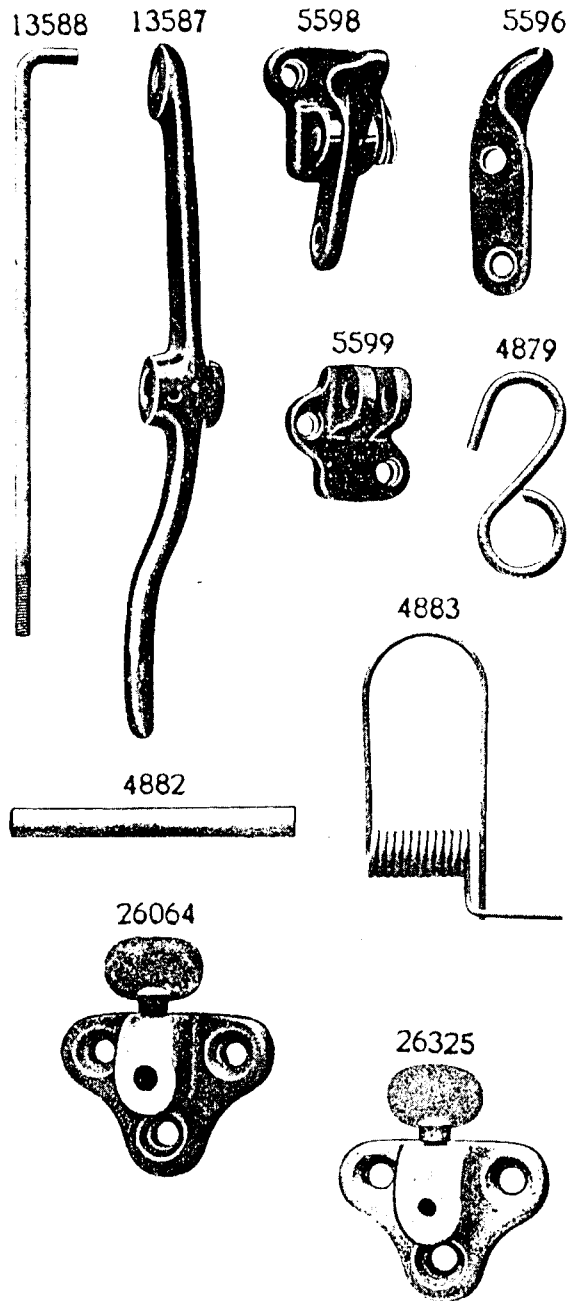

PLATE 7449—FULL SIZE

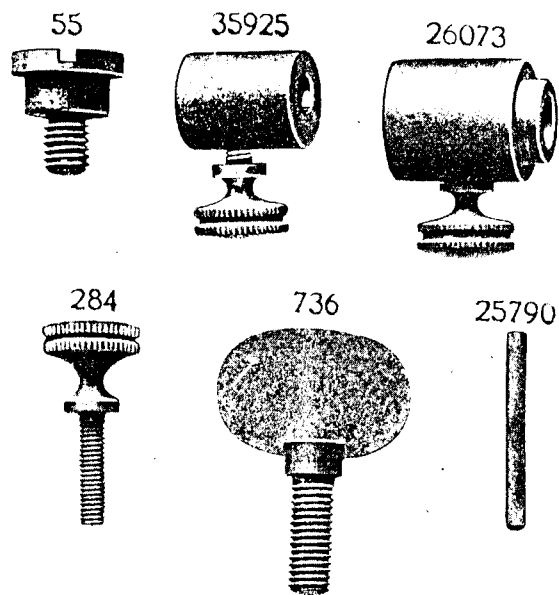



PLATE 7450—FULL SIZE

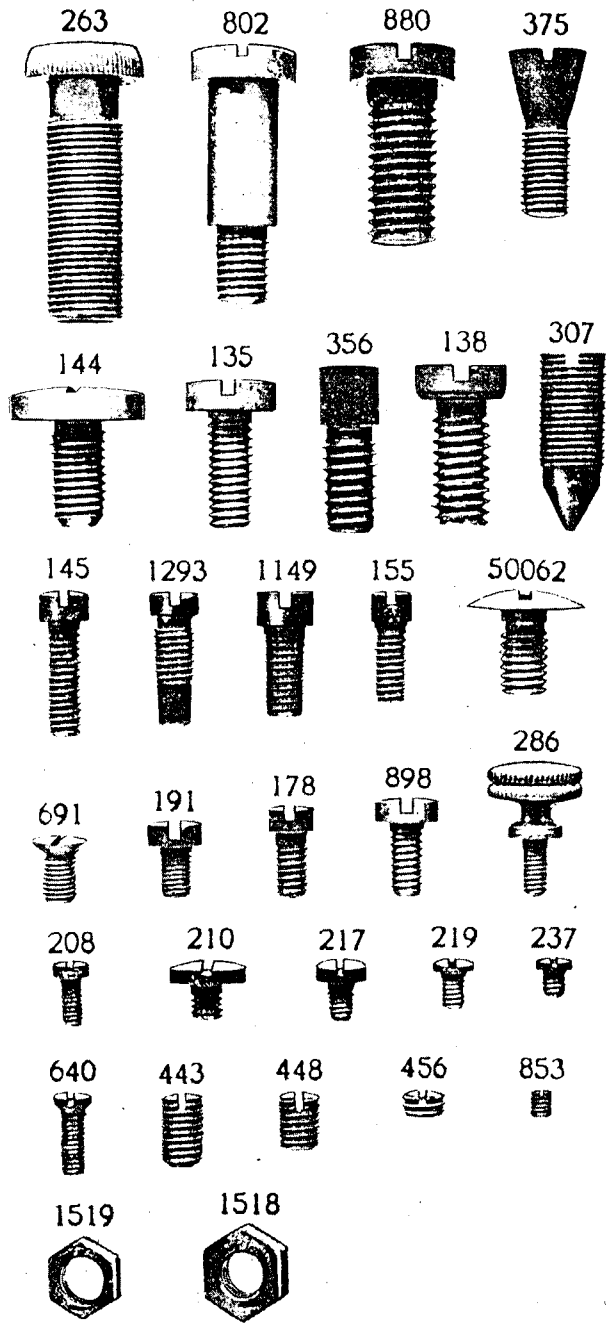
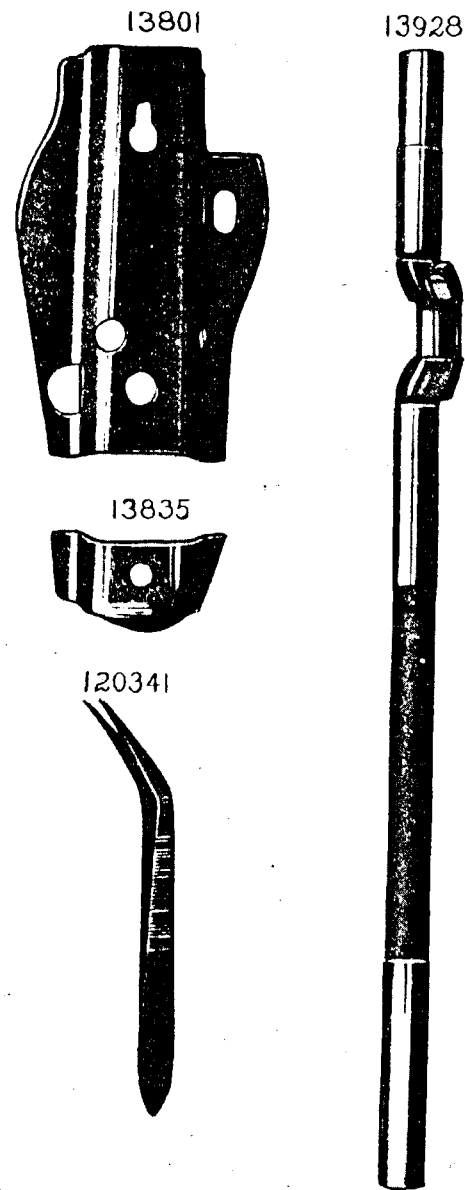

PLATE 7458—ONE-HALF SIZE



From the library of: Diamond Needle Corp

PLATE 7460—ONE-HALF SIZE

13837

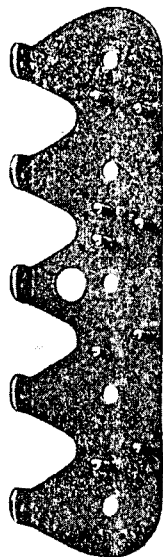
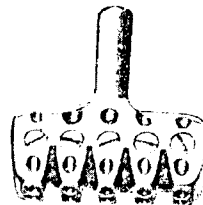
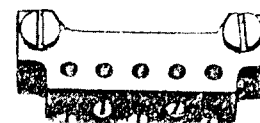

PLATE 7461—FULL SIZE

13817



13810



13841

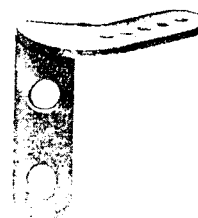

13560

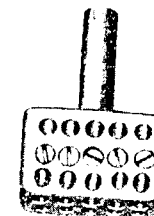

PLATE 7462—ONE-HALF SIZE

13840

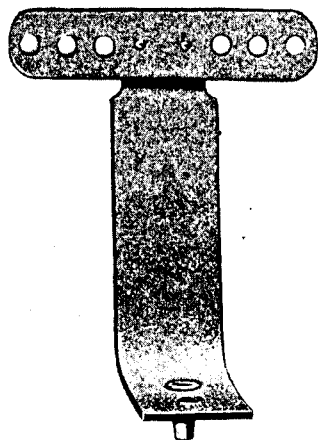

PLATE 7463—FULL SIZE

32675



13929



13930



15486



13617



13628



13843

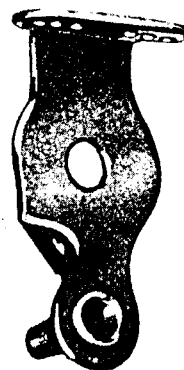

898



1454



211



201018



200383



201696



56865

13940

56864

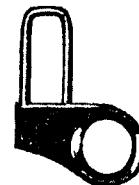
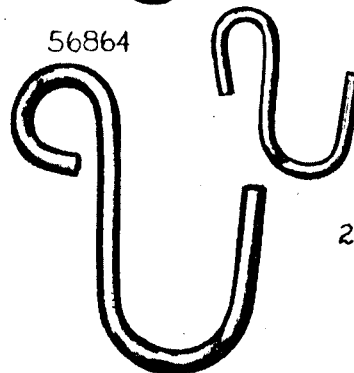

2269



225393



From the library of: Diamond Needle Corp

PLATE 7464—ONE-HALF SIZE

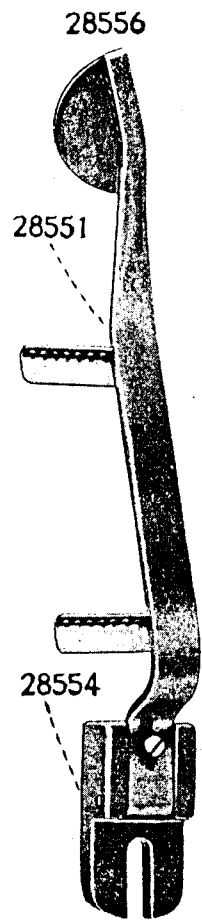
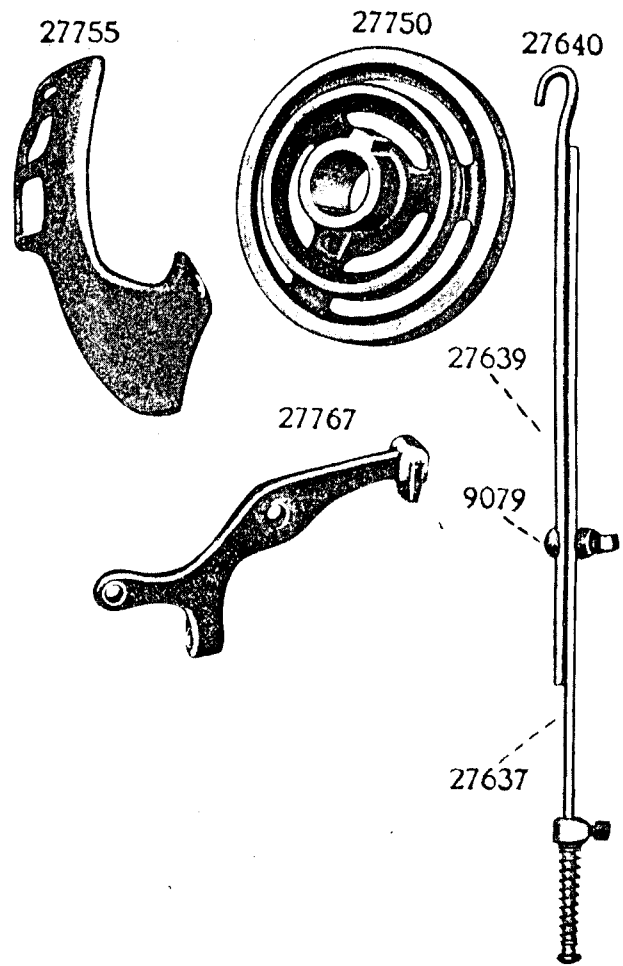

PLATE 7468—ONE-FOURTH SIZE



From the library of: Diamond Needle Corp

PLATE 7541—FULL SIZE

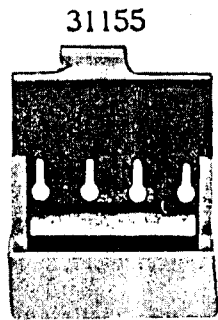
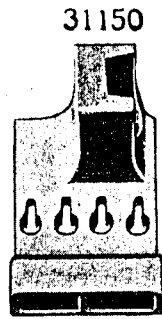
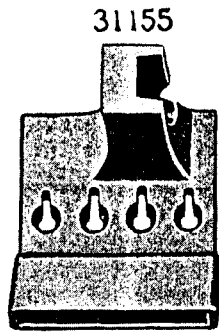

PLATE 7542—FULL SIZE

